

Flameproof and Increased Safety

EC2A

Explosion-protected Control Boxes



China NEPSI* approved

Applicable for any explosive gas in Zone 1 and 2 areas
Stainless steel plate enclosure with high corrosion resistance

*NEPSI: National Supervision and Inspection Center for Explosion Protection
and Safety of Instrumentation



Flameproof & Increased Safety EC2A Control

High corrosion and water resistance.



China NEPSI* approved

EC2A control boxes with stainless steel plate enclosure can be used in any explosive gas in Zones 1 and 2 areas. China NEPSI approved.

*NEPSI: National Supervision and Inspection Center for Explosion Protection and Safety of Instrumentation

Can be used in Zones 1 and 2!



Applicable in all hazardous locations

Explosion protection is Ex de IIC T6. Applicable in such gases as hydrogen, acetylene, carbon dioxide and nitrate.

Corrosion-resistant and waterproof construction

Stainless steel housing for either indoor or outdoor usage.
Degree of Protection: IP65

Conductor lead-in construction

Wall mount type
A reducer is furnished as standard for connecting a thick steel conduit to lead in a cable. When using a cable wiring, use an optional lead-in fitting (Type HPN).

Easy installation and removal

No bolt cup is furnished, allowing for easy maintenance. No special tools are required.

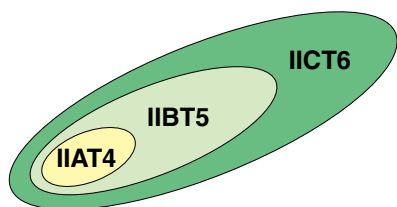

Applicable in all kinds of explosive gases for Division 1 or 2 Hazardous Areas.

Lightweight

Lightweight, increased safety construction.

Pole mount type

Only one cable can be led in the control box using a packing type lead-in method.

- Cable diameter
1 column: $\varnothing 8$ to $\varnothing 20$ mm
2 or 3 columns: $\varnothing 14$ to $\varnothing 26$ mm

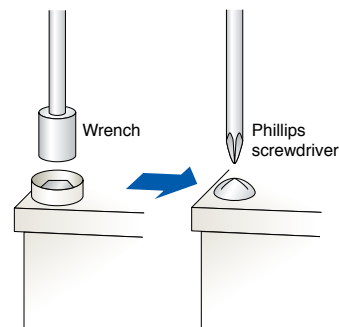

Boxes

■ Specifications

Explosion Protection	Ex de IIC T6
Degree of Protection	IP65 (IEC 60529)
Box Type	Wall mount and pole mount: 1 column: 1 to 5 control units 2 or 3 column: 2 to 5 control units
Standard Coating Color	Munsell 5Y7/1 (semi gloss) Melamine baking (10 µm thick) Coating on 1-column box: Outside only Coating on 2- and 3-column boxes: Inside & outside Pilot light bezel, meter housing, buzzer cap: Munsell N1.5 (semi gloss) melamine baking
Rated Insulation Voltage	500V
Dielectric Strength	2000V AC, 1 minute (between live and dead parts)
Operating Humidity	-20 to +50°C (no freezing)
Relative Humidity	45 to 85% (no condensation)
Altitude	2000m maximum

Wall Mount



- **Cable Lead-in Fitting**
Cable outside diameters
ø8 to ø20 mm (1-column box)
or ø14 to ø26 mm can be
connected.

- **Pole**
Material: Carbon steel
Outside diameter: ø48.6 mm

- **Pole Base**
Robust base allows for easy wiring.
Material: Cast iron



Pole Mount

Small meters

Small meters are equipped for mounting in ø30 mm mounting holes.

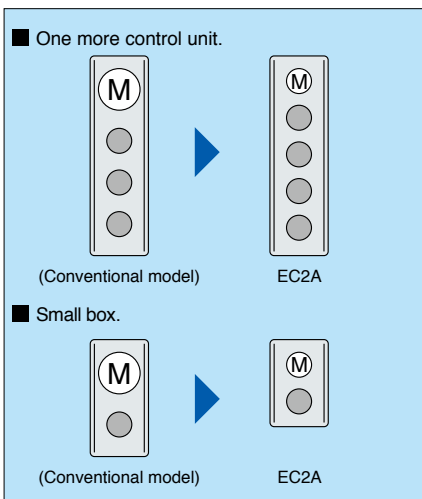

Variety of control units

- Wide selection of control units from ø30mm waterproof control units.
- Pilot lights use bright LEDs. LEDs offer long life and require no maintenance.
- Three color caps (black, green, red) are supplied with flush push-buttons.

■ Indication of Explosion Protection

Ex d e IIC T6

Ignition Group: T6

Allowable limits of maximum surface temperature of control equipment: 85°C (Applicable in the explosive gases which ignite at 85°C or higher)

Electrical Equipment Group

Applicable in explosive gases classified as A, B, or C for factory.

Increased Safety Construction (Box)

Flameproof Construction (Control Unit)

Symbol for Explosion Protection
Symbol for electrical equipment conforming to IEC standards.

EC2A Control Boxes

Applicable for any explosive gas in Zone 1 and 2 areas
Stainless steel plate enclosure with high corrosion resistance

Explosion protection	Ex de IIC T6
----------------------	--------------

- IEC60079 compliant
- All models have a hinged lid for easy wiring.
- Applicable in areas filled with all types of explosive gases such as hydrogen and acetylene gas.
- Various types of control units and boxes can be mounted.
- Degree of protection: IP65 (IEC60529)
- China NEPSI approved



Specifications

Explosion Protection	Ex de IIC T6
Degree of Protection	IP65 (IEC60529) (Key selector switch: IP54)
Box Type	Wall mounting and pole mounting 1-column: 1 to 5 control units 2- or 3-column: 2 to 5 control units
Material	Stainless steel (housing and lid)
Standard Coating Color	Munsell 5Y7/1 (semi gloss) Melamine baking (10 µm thick) Coating on 1-column box: Outside only Coating on 2- and 3-column boxes: Inside & outside Pilot light bezel, meter housing, buzzer cap: Munsell N1.5 (semi gloss) melamine baking
Rated Insulation Voltage	500V
Insulation Resistance	5 MΩ minimum (500V DC megger)
Dielectric Strength	2000V AC, 1 minute (between live and dead parts)
Operating Temperature	-20 to 50°C (no freezing)
Operating Humidity	45 to 85% RH (no condensation)
Altitude	2,000m maximum

Control Units

- EC9E-B Pushbutton
Flush pushbutton is supplied with three color caps (black, green, and red).
- EC9E-L Pilot Light
- EC9E-S Selector Switch
- EC9F-M Meter
- EC9F-Z Buzzer
- EC9E-R Variable Resistor (available on 2- and 3-column boxes only)

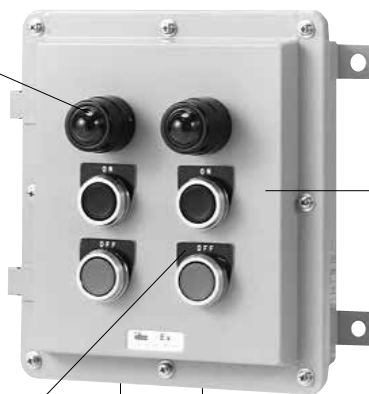

- **Nameplate**
NA Nameplate

- **Reducer**
For thick steel conduit
Material: Brass



Cable Lead-in Fitting

Cable outside diameters ø8 to ø20 mm (1-column box) or ø14 to ø26 mm can be connected.

Material: Brass

Pole

Material: Carbon steel
Outside diameter ø48.6 mm

Control Box

1-column: 1 to 5 control units
2- or 3-column: 2 to 5 control units

- **Pole Base**
Material: Cast iron

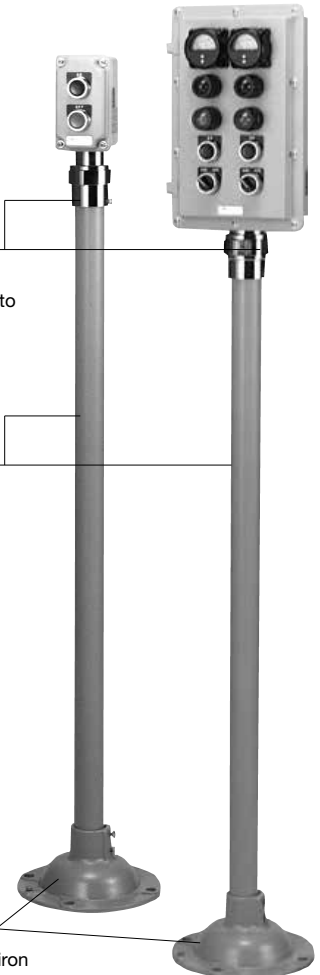

EC2A Flameproof and Increased Safety Control Boxes

1 Control Unit x 1 Column (With or Without Wiring)

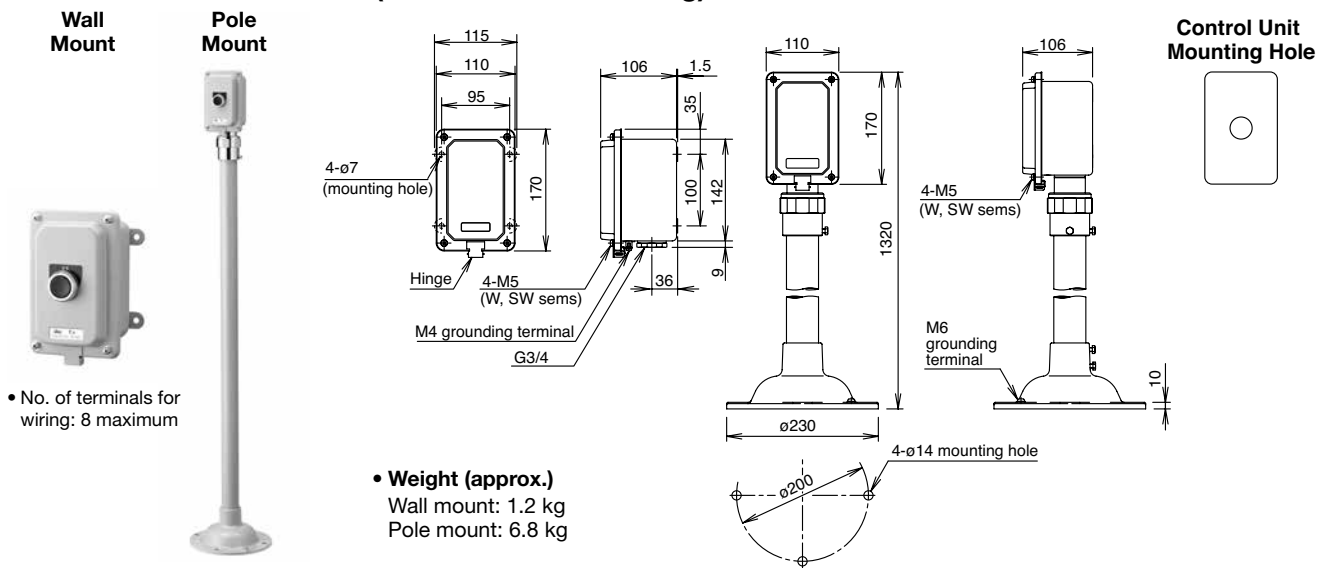

• Standard Model Part No.

Package quantity: 1

Symbol		Mounted Control Units				
		• 110V AC, Red lens	• 220V AC, Red lens	• 24V DC, Red lens	• 110V AC, Green lens	• 220V AC, Green lens
		Without Wiring	Wall Mount	EC2A-1101MF2N1	EC2A-1101MF2N2	EC2A-1101MF2N3
	Pole Mount	EC2A-1101MSFN1	EC2A-1101MSFN2	EC2A-1101MSFN3	EC2A-1101MSFN4	EC2A-1101MSFN5
With Wiring	Wall Mount	EC2A-1101MF2W1	EC2A-1101MF2W2	EC2A-1101MF2W3	EC2A-1101MF2W4	EC2A-1101MF2W5
	Pole Mount	EC2A-1101MSFW1	EC2A-1101MSFW2	EC2A-1101MSFW3	EC2A-1101MSFW4	EC2A-1101MSFW5
	Standard Wiring No.	①-1	①-1	①-1	①-1	①-1
TIIS Type Test Approval No.		TC16767				

Mounted Control Units			
• 24V DC, Green lens	• 110V AC, White lens	• 220V AC, White lens	• 24V DC, White lens
EC2A-1101MF2N6	EC2A-1101MF2N7	EC2A-1101MF2N8	EC2A-1101MF2N9
EC2A-1101MSFN6	EC2A-1101MSFN7	EC2A-1101MSFN8	EC2A-1101MSFN9
EC2A-1101MF2W6	EC2A-1101MF2W7	EC2A-1101MF2W8	EC2A-1101MF2W9
EC2A-1101MSFW6	EC2A-1101MSFW7	EC2A-1101MSFW8	EC2A-1101MSFW9
①-1	①-1	①-1	①-1
TC16767			

Note: When other mounted control units are required, use the Specification Sheet to specify the required control units.

Symbol		Mounted Control Units			
		• Flush, Momentary, 1NO-1NC contact Nameplate: ON	• Flush, Momentary, 1NO-1NC contact Nameplate: OFF	• Extended, Momentary 1NO-1NC contact Nameplate: ON Button color: Black	• Extended, Momentary 1NO-1NC contact Nameplate: OFF Button color: Red
		Without Wiring	Wall Mounting	EC2A-1102MF2N3	EC2A-1102MF2N4
	Pole Mounting	EC2A-1102MSFN3	EC2A-1102MSFN4	EC2A-1102MSFN5	EC2A-1102MSFN6
With Wiring	Wall Mounting	EC2A-1102MF2W3	EC2A-1102MF2W4	EC2A-1102MF2W5	EC2A-1102MF2W6
	Pole Mounting	EC2A-1102MSFW3	EC2A-1102MSFW4	EC2A-1102MSFW5	EC2A-1102MSFW6
	Standard Wiring No.	①-4	①-4	①-4	①-4
TIIS Type Test Approval No.		TC16767			

EC2A Flameproof and Increased Safety Control Boxes

Symbol		Mounted Control Units	
		<ul style="list-style-type: none"> • Flush, Momentary, 1NO-1NC contact Nameplate: START 	<ul style="list-style-type: none"> • Flush, Momentary, 1NO-1NC contact Nameplate: STOP
Without Wiring	Wall Mount	EC2A-1102MF2N8	EC2A-1102MF2N9
	Pole Mount	EC2A-1102MSFN8	EC2A-1102MSFN9
With Wiring	Wall Mount	EC2A-1102MF2W8	EC2A-1102MF2W9
	Pole Mount	EC2A-1102MSFW8	EC2A-1102MSFW9
	Standard Wiring No.	①-4	①-4
TIIS Type Test Approval No.		TC16767	

Note: When other mounted control units are required, use the Specification Sheet to specify the required control units.

Symbol		Mounted Control Units			
		<ul style="list-style-type: none"> • Knob operator, 2-position, Maintained, 1NO-1NC contact Nameplate: OFF-ON 	<ul style="list-style-type: none"> • Knob operator, 2-position, Maintained, 1NO-1NC contact Nameplate: HAND-AUTO 	<ul style="list-style-type: none"> • Lever operator, 2-position, Maintained, 1NO-1NC contact Nameplate: OFF-ON 	<ul style="list-style-type: none"> • Lever operator, 2-position, Maintained, 1NO-1NC contact Nameplate: HAND-AUTO
Without Wiring	Wall Mount	EC2A-1106MF2N1	EC2A-1106MF2N2	EC2A-1106MF2N4	EC2A-1106MF2N5
	Pole Mounting	EC2A-1106MSFN1	EC2A-1106MSFN2	EC2A-1106MSFN4	EC2A-1106MSFN5
With Wiring	Wall Mount	EC2A-1106MF2W1	EC2A-1106MF2W2	EC2A-1106MF2W4	EC2A-1106MF2W5
	Pole Mount	EC2A-1106MSFW1	EC2A-1106MSFW2	EC2A-1106MSFW4	EC2A-1106MSFW5
	Standard Wiring No.	①-5	①-5	①-5	①-5
TIIS Type Test Approval No.		TC16768			

Note: When other mounted control units are required, use the Specification Sheet to specify the required control units.

Symbol		Mounted Control Units	
		• 110V AC	• 220V AC
Without Wiring	Wall Mount	EC2A-1130MF2N1	EC2A-1130MF2N2
	Pole Mounting	EC2A-1130MSFN1	EC2A-1130MSFN2
With Wiring	Wall Mount	EC2A-1130MF2W1	EC2A-1130MF2W2
	Pole Mount	EC2A-1130MSFW1	EC2A-1130MSFW2
	Standard Wiring No.	①-7	①-7
TIIS Type Test Approval No.		TC16771	

Symbol		Mounted Control Units
		• Specify the capacity and scale.
Without Wiring	Wall Mount	EC2A-1150MF2N1
	Pole Mounting	EC2A-1150MSFN1
With Wiring	Wall Mount	EC2A-1150MF2W1
	Pole Mount	EC2A-1150MSFW1
	Standard Wiring No.	①-8
TIIS Type Test Approval No.		TC16773

Note: Use the Specification Sheet to specify the required meter capacity and scale.

[Standard Control Box]

- When required mounted units, control unit nameplate, and lead-in fitting are found in the standard control boxes, specify the Part No. to order the standard control boxes. When ordering a control box with a meter, specify the capacity and scale of the meter.
- For control unit specifications, see pages 24 to 26. For cable lead-in fitting specifications, see page 26. For control unit nameplate specifications, see page 28.
- Pushbuttons without color code designation are supplied with black, green, and red pushbutton color caps.
- If a control unit nameplate is not required on standard control boxes, add "0" after the Part No.

Example: **EC2A-1102MF2W30**

[Custom Assembled Control Box]





- If required control units, control unit nameplates, and cable lead-in fittings are not available with standard control boxes, specify the required items from the Specification Sheet on page 35.
- When the required control units, control unit nameplates, and cable lead-in fittings are not found in the Specification Sheet, specify your requirements separately.

[Remarks]

- Up to 10 letters of the Part No. can be indicated on the housing.

Example: **EC2A-1101M**

- The symbols of mounted control units are as follows:

 Pilot Light
  Pushbutton
  Selector Switch
 Buzzer
  Meter

EC2A Flameproof and Increased Safety Control Boxes

2 Control Units x 1 Column (With or Without Wiring)

Wall Mount

Pole Mount

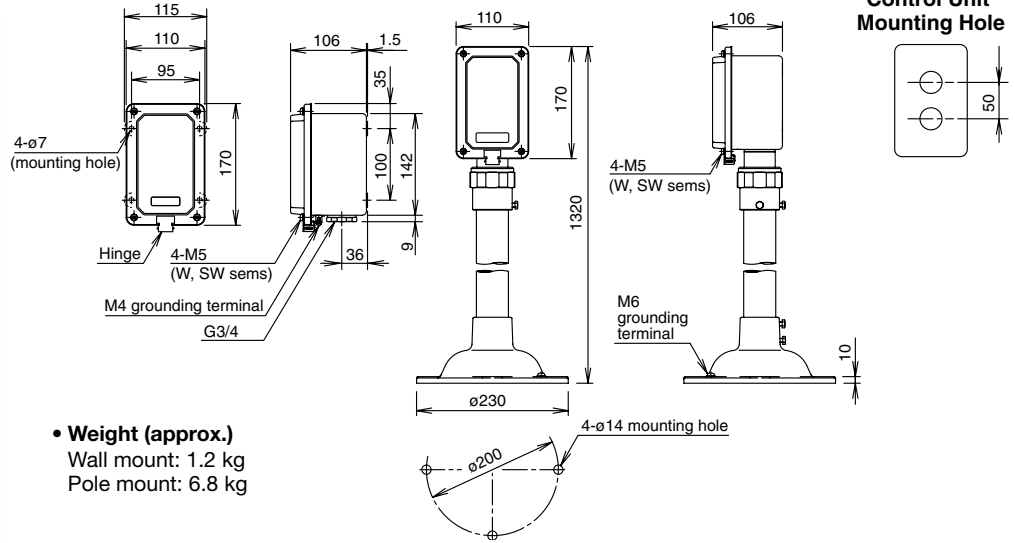

• No. of terminals for wiring: 8 maximum

• **Weight (approx.)**
 Wall mount: 1.2 kg
 Pole mount: 6.8 kg

• Standard Model Part No.

Package quantity: 1

Symbol		Mounted Control Units			
		• 110V AC, Red lens	• 220V AC, Red lens	• 24V DC, Red lens	• 110V AC, Red lens
		• 110V AC, Green lens	• 220V AC, Green lens	• 24V DC, Green lens	• 110V AC, Red lens
Without Wiring	Wall Mount	EC2A-2101MF2N1	EC2A-2101MF2N2	EC2A-2101MF2N3	EC2A-2101MF2N4
	Pole Mounting	EC2A-2101MSFN1	EC2A-2101MSFN2	EC2A-2101MSFN3	EC2A-2101MSFN4
With Wiring	Wall Mount	EC2A-2101MF2W1	EC2A-2101MF2W2	EC2A-2101MF2W3	EC2A-2101MF2W4
	Pole Mount	EC2A-2101MSFW1	EC2A-2101MSFW2	EC2A-2101MSFW3	EC2A-2101MSFW4
	Standard Wiring No.	②-1	②-1	②-1	②-1
TIIS Type Test Approval No.		TC16767			

Symbol		Mounted Control Units			
		• Flush, Momentary, 1NO-1NC contact Nameplate: ON	• Extended, Momentary, 1NO-1NC contact Nameplate: ON Button color: Black	• ø40 Mushroom Momentary, 1NO-1NC contact Nameplate: ON Button color: Black	• Flush, Momentary, 1NO-1NC contact Nameplate: START
		• Flush, Momentary, 1NO-1NC contact Nameplate: OFF	• Extended, Momentary, 1NO-1NC contact Nameplate: OFF Button color: Red	• ø40 Mushroom Momentary, 1NO-1NC contact Nameplate: OFF Button color: Red	• Flush, Momentary, 1NO-1NC contact Nameplate: STOP
Without Wiring	Wall Mount	EC2A-2102MF2N2	EC2A-2102MF2N5	EC2A-2102MF2N6	EC2A-2102MF2N7
	Pole Mounting	EC2A-2102MSFN2	EC2A-2102MSFN5	EC2A-2102MSFN6	EC2A-2102MSFN7
With Wiring	Wall Mount	EC2A-2102MF2W2	EC2A-2102MF2W5	EC2A-2102MF2W6	EC2A-2102MF2W7
	Pole Mount	EC2A-2102MSFW2	EC2A-2102MSFW5	EC2A-2102MSFW6	EC2A-2102MSFW7
	Standard Wiring No.	②-3	②-3	②-3	②-3
TIIS Type Test Approval No.		TC16767			

EC2A Flameproof and Increased Safety Control Boxes

Symbol		Mounted Control Units			
		<ul style="list-style-type: none"> • 110V AC, Red lens • Flush, Momentary, 1NO-1NC contact Nameplate: STOP 	<ul style="list-style-type: none"> • 220V AC, Red lens • Flush, Momentary, 1NO-1NC contact Nameplate: STOP 	<ul style="list-style-type: none"> • 24V DC, Red lens • Flush, Momentary, 1NO-1NC contact Nameplate: STOP 	<ul style="list-style-type: none"> • 110V AC, Red lens • Extended, Momentary, 1NO-1NC contact Nameplate: STOP Button color: Black
		EC2A-2112MF2N1	EC2A-2112MF2N2	EC2A-2112MF2N3	EC2A-2112MF2N4
Without Wiring	Wall Mount	EC2A-2112MSFN1	EC2A-2112MSFN2	EC2A-2112MSFN3	EC2A-2112MSFN4
	Pole Mounting	EC2A-2112MSFW1	EC2A-2112MSFW2	EC2A-2112MSFW3	EC2A-2112MSFW4
With Wiring	Wall Mount	EC2A-2112MSFN1	EC2A-2112MSFN2	EC2A-2112MSFN3	EC2A-2112MSFN4
	Pole Mount	EC2A-2112MSFW1	EC2A-2112MSFW2	EC2A-2112MSFW3	EC2A-2112MSFW4
	Standard Wiring No.	②-4	②-4	②-4	②-4
TIIS Type Test Approval No.		TC16767			

Symbol		Mounted Control Units	
		<ul style="list-style-type: none"> • 110V AC, Red lens • Knob operator, 2-position, Maintained, 1NO-1NC contact Nameplate: OFF-ON 	<ul style="list-style-type: none"> • 220V AC, Red lens • Knob operator, 2-position, Maintained, 1NO-1NC contact Nameplate: OFF-ON
		EC2A-2107MF2N1	EC2A-2107MF2N2
Without Wiring	Wall Mount	EC2A-2107MSFN1	EC2A-2107MSFN2
	Pole Mounting	EC2A-2107MSFW1	EC2A-2107MSFW2
With Wiring	Wall Mount	EC2A-2107MSFN1	EC2A-2107MSFN2
	Pole Mount	EC2A-2107MSFW1	EC2A-2107MSFW2
	Standard Wiring No.	②-5	②-5
TIIS Type Test Approval No.		TC16769	

Symbol		Mounted Control Units
		<ul style="list-style-type: none"> • 110V AC • Flush, Momentary, 1NO-1NC contact Nameplate: OFF
		EC2A-2132MF2N1
Without Wiring	Wall Mount	EC2A-2132MSFN1
	Pole Mounting	EC2A-2132MSFW1
With Wiring	Wall Mount	EC2A-2132MSFN1
	Pole Mount	EC2A-2132MSFW1
	Standard Wiring No.	②-6
TIIS Type Test Approval No.		TC16771

[Standard Control Box]

- When required mounted units, control unit nameplate, and lead-in fitting are found in the standard control boxes, specify the Part No. to order the standard control boxes. When ordering a control box with a meter, specify the capacity and scale of the meter.
- For control unit specifications, see pages 24 to 26. For cable lead-in fitting specifications, see page 26. For control unit nameplate specifications, see page 28.
- Pushbuttons without color code designation are supplied with black, green, and red pushbutton color caps.
- If control unit nameplates are not required on standard control boxes, add "0" after the Part No.

Example: **EC2A-2112MF2W10**

[Custom Assembled Control Box]

- If required control units, control unit nameplates, and cable lead-in fittings are not available with standard control boxes, specify the required items from the Specification Sheet on page 35.
- When the required control units, control unit nameplates, and cable lead-in fittings are not found in the Specification Sheet, specify your requirements separately.

[Remarks]

- Up to 10 letters of the Part No. can be indicated on the housing.

Example: **EC2A-2112M**

- The symbols of mounted control units are as follows:

Pilot Light
 Pushbutton
 Selector Switch
 Buzzer
 Meter

EC2A Flameproof and Increased Safety Control Boxes

3 Control Units x 1 Column (With or Without Wiring)

Wall Mount



• No. of terminals for wiring: 8 maximum

Pole Mount

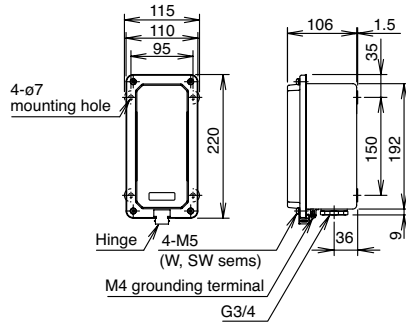

• **Weight (approx.)**
 Wall mount: 1.6 kg
 Pole mount: 7.2 kg

Control Unit Mounting Hole

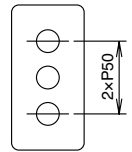

• Standard Model Part No.

Package quantity: 1

Symbol		Mounted Control Units
		<ul style="list-style-type: none"> • 110V AC, Red lens • 110V AC, Red lens • 110V AC, Red lens
Without Wiring	Wall Mount	EC2A-3101MF2N1
	Pole Mount	EC2A-3101MSFN1
With Wiring	Wall Mount	EC2A-3101MF2W1
	Pole Mount	EC2A-3101MSFW1
	Standard Wiring No.	③-8
TIIS Type Test Approval No.		TC16776

Symbol		Mounted Control Units
		<ul style="list-style-type: none"> • Flush, Momentary, 1NO-1NC contact Nameplate: FORWARD • Flush, Momentary, 1NO-1NC contact Nameplate: REVERSE • Flush, Momentary, 1NO-1NC contact Nameplate: STOP
Without Wiring	Wall Mount	EC2A-3102MF2N1
	Pole Mount	EC2A-3102MSFN1
With Wiring	Wall Mount	EC2A-3102MF2W1
	Pole Mount	EC2A-3102MSFW1
	Standard Wiring No.	③-7
TIIS Type Test Approval No.		TC16776

Symbol		Mounted Control Units
		<ul style="list-style-type: none"> • 110V AC, Red lens • Flush, Momentary, 1NO-1NC contact Nameplate: ON • Flush, Momentary, 1NO-1NC contact Nameplate: OFF
Without Wiring	Wall Mount	EC2A-3110MF2N4
	Pole Mount	EC2A-3110MSFN4
With Wiring	Wall Mount	EC2A-3110MF2W4
	Pole Mount	EC2A-3110MSFW4
	Standard Wiring No.	③-2
TIIS Type Test Approval No.		TC16776

Symbol		Mounted Control Units
		<ul style="list-style-type: none"> • 110V AC, Red lens • Flush, Momentary, 1NO-1NC contact Nameplate: STOP • Knob operator, 2-position, Maintained, 1NO-1NC contact Nameplate: OFF-ON
Without Wiring	Wall Mount	EC2A-3113MF2N1
	Pole Mount	EC2A-3113MSFN1
With Wiring	Wall Mount	EC2A-3113MF2W1
	Pole Mount	EC2A-3113MSFW1
	Standard Wiring No.	③-9
TIIS Type Test Approval No.		TC16776

Note: When other mounted control units are required, use the Specification Sheet to specify the required control units.

EC2A Flameproof and Increased Safety Control Boxes

Symbol		Mounted Control Units
		<ul style="list-style-type: none"> Specify the capacity and scale. Flush, Momentary, 1NO-1NC contact Nameplate: ON Flush, Momentary, 1NO-1NC contact Nameplate: OFF
Without Wiring	Wall Mount	EC2A-3152MF2N2
	Pole Mount	EC2A-3152MSFN2
With Wiring	Wall Mount	EC2A-3152MF2W2
	Pole Mount	EC2A-3152MSFW2
	Standard Wiring No.	③-6
TIIS Type Test Approval No.		TC16782

Symbol		Mounted Control Units		
		<ul style="list-style-type: none"> Specify the capacity and scale. 110V AC, Red lens Knob operator, 2-position, Maintained, 1NO-1NC contact Nameplate: OFF-ON 	<ul style="list-style-type: none"> Specify the capacity and scale. 220V AC, Red lens Knob operator, 2-position, Maintained, 1NO-1NC contact Nameplate: OFF-ON 	<ul style="list-style-type: none"> Specify the capacity and scale. 24V DC, Red lens Knob operator, 2-position, Maintained, 1NO-1NC contact Nameplate: OFF-ON
Without Wiring	Wall Mount	EC2A-3157MF2N1	EC2A-3157MF2N2	EC2A-3157MF2N3
	Pole Mount	EC2A-3157MSFN1	EC2A-3157MSFN2	EC2A-3157MSFN3
With Wiring	Wall Mount	EC2A-3157MF2W1	EC2A-3157MF2W2	EC2A-3157MF2W3
	Pole Mount	EC2A-3157MSFW1	EC2A-3157MSFW2	EC2A-3157MSFW3
	Standard Wiring No.	③-3	③-3	③-3
TIIS Type Test Approval No.		TC16781		

Symbol		Mounted Control Units
		<ul style="list-style-type: none"> 110V AC 110V AC, Red lens Flush, Momentary, 1NO-1NC contact Nameplate: STOP
Without Wiring	Wall Mount	EC2A-3130MF2N1
	Pole Mount	EC2A-3130MSFN1
With Wiring	Wall Mount	EC2A-3130MF2W1
	Pole Mount	EC2A-3130MSFW1
	Standard Wiring No.	③-10
TIIS Type Test Approval No.		TC16777

[Standard Control Box]

- When required mounted units, control unit nameplate, and lead-in fitting are found in the standard control boxes, specify the Part No. to order the standard control boxes. When ordering a control box with a meter, specify the capacity and scale of the meter.
- For control unit specifications, see pages 24 to 26. For cable lead-in fitting specifications, see page 26. For control unit nameplate specifications, see page 28.
- Pushbuttons without color code designation are supplied with black, green, and red pushbutton color caps.
- If a control unit nameplate is not required on standard control boxes, add "0" after the Part No.

Example: **EC2A-3110MF2W40**

[Custom Assembled Control Box]

- If required control units, control unit nameplates, and cable lead-in fittings are not available with standard control boxes, specify the required items from the Specification Sheet on page 35.

- When the required control units, control unit nameplates, and cable lead-in fittings are not found in the Specification Sheet, specify your requirements separately.

[Remarks]

- Up to 10 letters of the Part No. can be indicated on the housing.

Example: **EC2A-3101M**

- The symbols of mounted control units are as follows:

Pilot Light
 Pushbutton
 Selector Switch
 Buzzer
 Meter

EC2A Flameproof and Increased Safety Control Boxes

4 Control Units x 1 Column (With or Without Wiring)

Wall Mount

Pole Mount

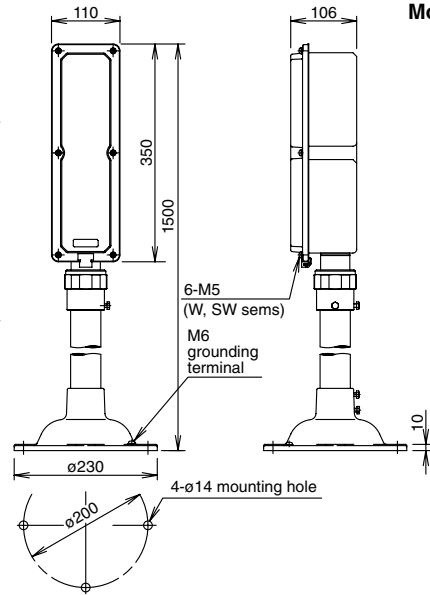
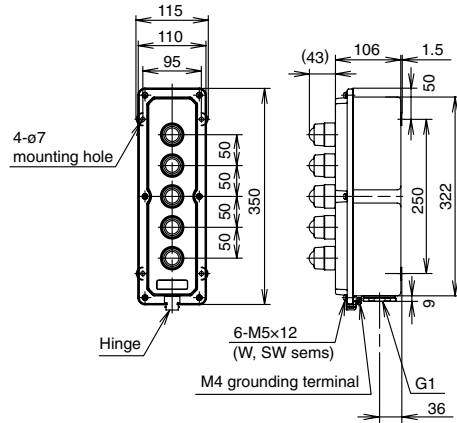

Control Unit Mounting Hole

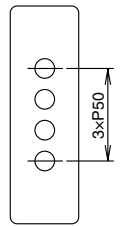

• No. of terminals for wiring: 16 maximum

• **Weight (approx.)**
Wall mount: 2.4 kg
Pole mount: 8.0 kg

• Standard Model Part No.

Package quantity: 1

Symbol		Mounted Control Units
		<ul style="list-style-type: none"> • 110V AC, Red lens • 110V AC, Red lens • 110V AC, Red lens • 110V AC, Red lens
Without Wiring	Wall Mount	EC2A-4101NF3N1
	Pole Mount	EC2A-4101NSFN1
With Wiring	Wall Mount	EC2A-4101NF3W1
	Pole Mount	EC2A-4101NSFW1
	Standard Wiring No.	④-3
TIIS Type Test Approval No.		TC14279

Symbol		Mounted Control Units
		<ul style="list-style-type: none"> • Flush, Momentary, 1NO-1NC contact With NA-0 nameplate • Flush, Momentary, 1NO-1NC contact With NA-0 nameplate • Flush, Momentary, 1NO-1NC contact With NA-0 nameplate • Flush, Momentary, 1NO-1NC contact With NA-0 nameplate
Without Wiring	Wall Mount	EC2A-4102NF3N1
	Pole Mount	EC2A-4102NSFN1
With Wiring	Wall Mount	EC2A-4102NF3W1
	Pole Mount	EC2A-4102NSFW1
	Standard Wiring No.	④-6
TIIS Type Test Approval No.		TC14279

Symbol		Mounted Control Units			
		<ul style="list-style-type: none"> • 110V AC, Red lens • 110V AC, Green lens • Flush, Momentary, 1NO-1NC contact Nameplate: ON • Flush, Momentary, 1NO-1NC contact Nameplate: OFF 	<ul style="list-style-type: none"> • 220V AC, Red lens • 220V AC, Green lens • Flush, Momentary, 1NO-1NC contact Nameplate: ON • Flush, Momentary, 1NO-1NC contact Nameplate: OFF 	<ul style="list-style-type: none"> • 24V DC, Red lens • 24V DC, Green lens • Flush, Momentary, 1NO-1NC contact Nameplate: ON • Flush, Momentary, 1NO-1NC contact Nameplate: OFF 	<ul style="list-style-type: none"> • 110V AC, Red lens • 110V AC, Green lens • Extended, Momentary, 1NO-1NC contact Nameplate: ON Button color: Black • Extended, Momentary, 1NO-1NC contact Nameplate: OFF Button color: Red
Without Wiring	Wall Mount	EC2A-4110NF3N1	EC2A-4110NF3N2	EC2A-4110NF3N3	EC2A-4110NF3N4
	Pole Mount	EC2A-4110NSFN1	EC2A-4110NSFN2	EC2A-4110NSFN3	EC2A-4110NSFN4
With Wiring	Wall Mount	EC2A-4110NF3W1	EC2A-4110NF3W2	EC2A-4110NF3W3	EC2A-4110NF3W4
	Pole Mount	EC2A-4110NSFW1	EC2A-4110NSFW2	EC2A-4110NSFW3	EC2A-4110NSFW4
	Standard Wiring No.	④-1	④-1	④-1	④-1
TIIS Type Test Approval No.		TC14279			

Note: When other mounted control units are required, use the Specification Sheet to specify the required control units.

EC2A Flameproof and Increased Safety Control Boxes

Symbol		Mounted Control Units	
		<ul style="list-style-type: none"> • 110V AC, Red lens • Flush, Momentary, 1NO-1NC contact Nameplate: ON • Flush, Momentary, 1NO-1NC contact Nameplate: OFF • Knob operator, 2-position, Maintained, 1NO-1NC contact Nameplate: HAND-AUTO 	<ul style="list-style-type: none"> • 220V AC, Red lens • Flush, Momentary, 1NO-1NC contact Nameplate: ON • Flush, Momentary, 1NO-1NC contact Nameplate: OFF • Knob operator, 2-position, Maintained, 1NO-1NC contact Nameplate: HAND-AUTO
Without Wiring	Wall Mount	EC2A-4113NF3N1	EC2A-4113NF3N2
	Pole Mount	EC2A-4113NSFN1	EC2A-4113NSFN2
With Wiring	Wall Mount	EC2A-4113NF3W1	EC2A-4113NF3W2
	Pole Mount	EC2A-4113NSFW1	EC2A-4113NSFW2
	Standard Wiring No.	④-5	④-5
TIIS Type Test Approval No.		TC14279	

Symbol		Mounted Control Units			
		<ul style="list-style-type: none"> • Specify the capacity and scale. • 110V AC, Red lens • Flush, Momentary, 1NO-1NC contact Nameplate: ON • Flush, Momentary, 1NO-1NC contact Nameplate: OFF 	<ul style="list-style-type: none"> • Specify the capacity and scale. • 220V AC, Red lens • Flush, Momentary, 1NO-1NC contact Nameplate: ON • Flush, Momentary, 1NO-1NC contact Nameplate: OFF 	<ul style="list-style-type: none"> • Specify the capacity and scale. • 24V DC, Red lens • Flush, Momentary, 1NO-1NC contact Nameplate: ON • Flush, Momentary, 1NO-1NC contact Nameplate: OFF 	<ul style="list-style-type: none"> • Specify the capacity and scale. • 110V AC, Red lens • Extended, Momentary, 1NO-1NC contact Nameplate: ON Button color: Black • Extended, Momentary, 1NO-1NC contact Nameplate: OFF Button color: Red
Without Wiring	Wall Mount	EC2A-4150NF3N1	EC2A-4150NF3N2	EC2A-4150NF3N3	EC2A-4150NF3N4
	Pole Mount	EC2A-4150NSFN1	EC2A-4150NSFN2	EC2A-4150NSFN3	EC2A-4150NSFN4
With Wiring	Wall Mount	EC2A-4150NF3W1	EC2A-4150NF3W2	EC2A-4150NF3W3	EC2A-4150NF3W4
	Pole Mount	EC2A-4150NSFW1	EC2A-4150NSFW2	EC2A-4150NSFW3	EC2A-4150NSFW4
	Standard Wiring No.	④-2	④-2	④-2	④-2
TIIS Type Test Approval No.		TC14279			

Symbol		Mounted Control Units
		<ul style="list-style-type: none"> • Specify the capacity and scale. • Flush, Momentary, 1NO-1NC contact Nameplate: ON • Flush, Momentary, 1NO-1NC contact Nameplate: OFF • Knob operator, 2-position, Maintained, 1NO-1NC contact Nameplate: HAND-AUTO
Without Wiring	Wall Mount	EC2A-4154NF3N1
	Pole Mount	EC2A-4154NSFN1
With Wiring	Wall Mount	EC2A-4154NF3W1
	Pole Mount	EC2A-4154NSFW1
	Standard Wiring No.	④-4
TIIS Type Test Approval No.		TC14279

[Standard Control Box]

- When required mounted units, control unit nameplate, and lead-in fitting are found in the standard control boxes, specify the Part No. to order the standard control boxes. When ordering a control box with a meter, specify the capacity and scale of the meter.
- For control unit specifications, see pages 24 to 26. For cable lead-in fitting specifications, see page 26. For control unit nameplate specifications, see page 28.
- Pushbuttons without color code designation are supplied with black, green, and red pushbutton color caps.

- If a control unit nameplate is not required on standard control boxes, add "0" after the Part No.

Example: **EC2A-4110NF3W10**

[Custom Assembled Control Box]





- If required control units, control unit nameplates, and cable lead-in fittings are not available with standard control boxes, specify the required items from the Specification Sheet on page 35.
- When the required control units, control unit nameplates, and cable lead-in fittings are not found in the Specification Sheet, specify your requirements separately.

[Remarks]

- Up to 9 letters of the Part No. can be indicated on the housing.

Example: **EC2A-4110**

- The symbols of mounted control units are as follows:

-  Pilot Light
  Pushbutton
  Selector Switch
 Buzzer
  Meter

EC2A Flameproof and Increased Safety Control Boxes

5 Control Units x 1 Column (With or Without Wiring)

Wall Mount

Pole Mount

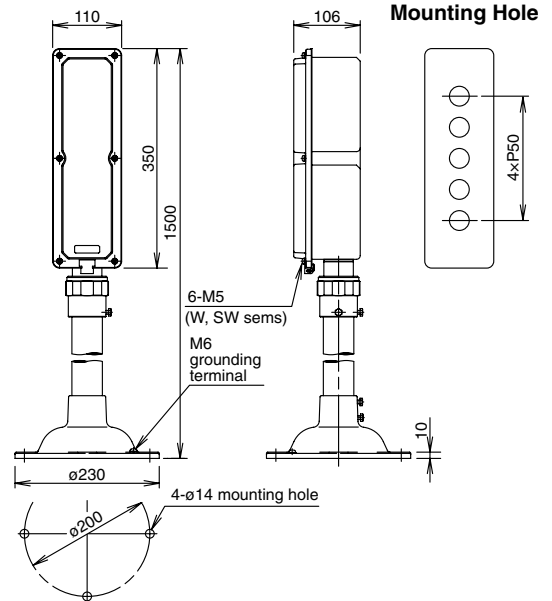
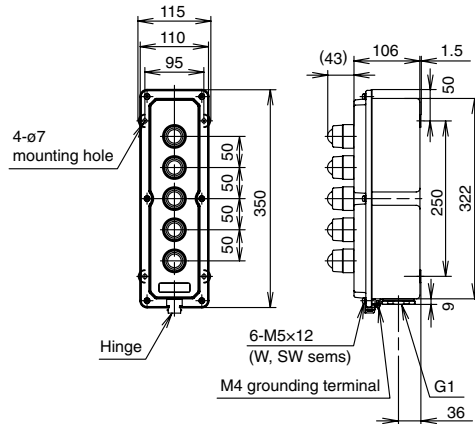

Control Unit Mounting Hole

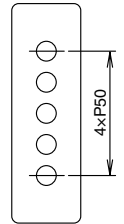

• No. of terminals for wiring: 16 maximum

• **Weight (approx.)**
Wall mount: 2.4 kg
Pole mount: 8.0 kg

• Standard Model Part No.

Package quantity: 1

Symbol		Mounted Control Units
		<ul style="list-style-type: none"> • 110V AC, Red lens • 110V AC, Red lens • 110V AC, Red lens • 110V AC, Red lens • 110V AC, Red lens
Without Wiring	Wall Mount	EC2A-5101NF3N1
	Pole Mount	EC2A-5101NSFN1
With Wiring	Wall Mount	EC2A-5101NF3W1
	Pole Mount	EC2A-5101NSFW1
	Standard Wiring No.	⑤-4
TIIS Type Test Approval No.		TC14279

Symbol		Mounted Control Units
		<ul style="list-style-type: none"> • Flush, Momentary, 1NO-1NC contact With NA-0 nameplate • Flush, Momentary, 1NO-1NC contact With NA-0 nameplate • Flush, Momentary, 1NO-1NC contact With NA-0 nameplate • Flush, Momentary, 1NO-1NC contact With NA-0 nameplate • Flush, Momentary, 1NO-1NC contact With NA-0 nameplate • Flush, Momentary, 1NO-1NC contact With NA-0 nameplate
Without Wiring	Wall Mount	EC2A-5102NF3N1
	Pole Mount	EC2A-5102NSFN1
With Wiring	Wall Mount	EC2A-5102NF3W1
	Pole Mount	EC2A-5102NSFW1
	Standard Wiring No.	⑤-6
TIIS Type Test Approval No.		TC14279

Symbol		Mounted Control Units			
		<ul style="list-style-type: none"> • 110V AC, Red lens • 110V AC, Green lens • Flush, Momentary, 1NO-1NC contact Nameplate: FORWARD • Flush, Momentary, 1NO-1NC contact Nameplate: REVERSE • Flush, Momentary, 1NO-1NC contact Nameplate: STOP 	<ul style="list-style-type: none"> • 220V AC, Red lens • 220V AC, Green lens • Flush, Momentary, 1NO-1NC contact Nameplate: FORWARD • Flush, Momentary, 1NO-1NC contact Nameplate: REVERSE • Flush, Momentary, 1NO-1NC contact Nameplate: STOP 	<ul style="list-style-type: none"> • 24V DC, Red lens • 24V DC, Green lens • Flush, Momentary, 1NO-1NC contact Nameplate: FORWARD • Flush, Momentary, 1NO-1NC contact Nameplate: REVERSE • Flush, Momentary, 1NO-1NC contact Nameplate: STOP 	<ul style="list-style-type: none"> • 110V AC, Red lens • 110V AC, Green lens • Extended, Momentary, 1NO-1NC contact Nameplate: FORWARD Button color: Black • Extended, Momentary, 1NO-1NC contact Nameplate: REVERSE Button color: Black • Extended, Momentary, 1NO-1NC contact Nameplate: STOP Button color: Red
Without Wiring	Wall Mount	EC2A-5110NF3N1	EC2A-5110NF3N2	EC2A-5110NF3N3	EC2A-5110NF3N4
	Pole Mount	EC2A-5110NSFN1	EC2A-5110NSFN2	EC2A-5110NSFN3	EC2A-5110NSFN4
With Wiring	Wall Mount	EC2A-5110NF3W1	EC2A-5110NF3W2	EC2A-5110NF3W3	EC2A-5110NF3W4
	Pole Mount	EC2A-5110NSFW1	EC2A-5110NSFW2	EC2A-5110NSFW3	EC2A-5110NSFW4
	Standard Wiring No.	⑤-1	⑤-1	⑤-1	⑤-1
TIIS Type Test Approval No.		TC14279			

Note: When other mounted control units are required, use the Specification Sheet to specify the required control units.

EC2A Flameproof and Increased Safety Control Boxes

Symbol		Mounted Control Units																													
		<ul style="list-style-type: none"> • 110V AC, Red lens • 110V AC, Green lens • Flush, Momentary, 1NO-1NC contact Nameplate: ON • Flush, Momentary, 1NO-1NC contact Nameplate: OFF • Knob operator, 2-position, Maintained, 1NO-1NC contact Nameplate: HAND-AUTO 	<ul style="list-style-type: none"> • 220V AC, Red lens • 220V AC, Green lens • Flush, Momentary, 1NO-1NC contact Nameplate: ON • Flush, Momentary, 1NO-1NC contact Nameplate: OFF • Knob operator, 2-position, Maintained, 1NO-1NC contact Nameplate: HAND-AUTO 	<ul style="list-style-type: none"> • 24V DC, Red lens • 24V DC, Green lens • Flush, Momentary, 1NO-1NC contact Nameplate: ON • Flush, Momentary, 1NO-1NC contact Nameplate: OFF • Knob operator, 2-position, Maintained, 1NO-1NC contact Nameplate: HAND-AUTO 	<ul style="list-style-type: none"> • 110V AC, Red lens • 110V AC, Green lens • Extended, Momentary, 1NO-1NC contact Nameplate: ON • Button color: Black • Extended, Momentary, 1NO-1NC contact Nameplate: OFF • Button color: Red • 2-position, Maintained, 1NO-1NC contact Nameplate: HAND-AUTO 																										
		<table border="1"> <tr> <td>Without Wiring</td> <td>Wall Mount</td> <td>EC2A-5113NF3N1</td> <td>EC2A-5113NF3N2</td> <td>EC2A-5113NF3N3</td> <td>EC2A-5113NF3N4</td> </tr> <tr> <td></td> <td>Pole Mount</td> <td>EC2A-5113NSFN1</td> <td>EC2A-5113NSFN2</td> <td>EC2A-5113NSFN3</td> <td>EC2A-5113NSFN4</td> </tr> </table>	Without Wiring	Wall Mount	EC2A-5113NF3N1	EC2A-5113NF3N2	EC2A-5113NF3N3	EC2A-5113NF3N4		Pole Mount	EC2A-5113NSFN1	EC2A-5113NSFN2	EC2A-5113NSFN3	EC2A-5113NSFN4	<table border="1"> <tr> <td>With Wiring</td> <td>Wall Mount</td> <td>EC2A-5113NF3W1</td> <td>EC2A-5113NF3W2</td> <td>EC2A-5113NF3W3</td> <td>EC2A-5113NF3W4</td> </tr> <tr> <td></td> <td>Pole Mount</td> <td>EC2A-5113NSFW1</td> <td>EC2A-5113NSFW2</td> <td>EC2A-5113NSFW3</td> <td>EC2A-5113NSFW4</td> </tr> <tr> <td></td> <td>Standard Wiring No.</td> <td>⑤-2</td> <td>⑤-2</td> <td>⑤-2</td> <td>⑤-2</td> </tr> </table>	With Wiring	Wall Mount	EC2A-5113NF3W1	EC2A-5113NF3W2	EC2A-5113NF3W3	EC2A-5113NF3W4		Pole Mount	EC2A-5113NSFW1	EC2A-5113NSFW2	EC2A-5113NSFW3	EC2A-5113NSFW4		Standard Wiring No.	⑤-2	⑤-2
Without Wiring	Wall Mount	EC2A-5113NF3N1	EC2A-5113NF3N2	EC2A-5113NF3N3	EC2A-5113NF3N4																										
	Pole Mount	EC2A-5113NSFN1	EC2A-5113NSFN2	EC2A-5113NSFN3	EC2A-5113NSFN4																										
With Wiring	Wall Mount	EC2A-5113NF3W1	EC2A-5113NF3W2	EC2A-5113NF3W3	EC2A-5113NF3W4																										
	Pole Mount	EC2A-5113NSFW1	EC2A-5113NSFW2	EC2A-5113NSFW3	EC2A-5113NSFW4																										
	Standard Wiring No.	⑤-2	⑤-2	⑤-2	⑤-2																										
TIIS Type Test Approval No.		TC14279																													

Symbol		Mounted Control Units				
		<ul style="list-style-type: none"> • Specify the capacity and scale. • 110V AC, Red lens • 110V AC, Green lens • Flush, Momentary, 1NO-1NC contact Nameplate: ON • Flush, Momentary, 1NO-1NC contact Nameplate: OFF 				
		<table border="1"> <tr> <td>Without Wiring</td> <td>Wall Mount</td> <td>EC2A-5150NF3N1</td> </tr> <tr> <td></td> <td>Pole Mount</td> <td>EC2A-5150NSFN1</td> </tr> </table>	Without Wiring	Wall Mount	EC2A-5150NF3N1	
Without Wiring	Wall Mount	EC2A-5150NF3N1				
	Pole Mount	EC2A-5150NSFN1				
With Wiring	Wall Mount	EC2A-5150NF3W1				
	Pole Mount	EC2A-5150NSFW1				
	Standard Wiring No.	⑤-3				
TIIS Type Test Approval No.		TC14279				

Symbol		Mounted Control Units				
		<ul style="list-style-type: none"> • Specify the capacity and scale. • 110V AC, Red lens • Flush, Momentary, 1NO-1NC contact Nameplate: ON • Flush, Momentary, 1NO-1NC contact Nameplate: OFF • Knob operator, 2-position, Maintained, 1NO-1NC contact Nameplate: HAND-AUTO 				
		<table border="1"> <tr> <td>Without Wiring</td> <td>Wall Mount</td> <td>EC2A-5153NF3N1</td> </tr> <tr> <td></td> <td>Pole Mount</td> <td>EC2A-5153NSFN1</td> </tr> </table>	Without Wiring	Wall Mount	EC2A-5153NF3N1	
Without Wiring	Wall Mount	EC2A-5153NF3N1				
	Pole Mount	EC2A-5153NSFN1				
With Wiring	Wall Mount	EC2A-5153NF3W1				
	Pole Mount	EC2A-5153NSFW1				
	Standard Wiring No.	⑤-5				
TIIS Type Test Approval No.		TC14279				

[Standard Control Box]

- When required mounted units, control unit nameplate, and lead-in fitting are found in the standard control boxes, specify the Part No. to order the standard control boxes. When ordering a control box with a meter, specify the capacity and scale of the meter.
- For control unit specifications, see pages 24 to 26. For cable lead-in fitting specifications, see page 26. For control unit nameplate specifications, see page 28.
- Pushbuttons without color code designation are supplied with black, green, and red pushbutton color caps.
- If a control unit nameplate is not required on standard control boxes, add "0" after the Part No.

Example: **EC2A-5110NF3W10**

[Custom Assembled Control Box]

- If required control units, control unit nameplates, and cable lead-in fittings are not available with standard control boxes, specify the required items from the Specification Sheet on page 35.
- When the required control units, control unit nameplates, and cable lead-in fittings are not found in the Specification Sheet, specify your requirements separately.

[Remarks]

- Up to 9 letters of the Part No. can be indicated on the housing.

Example: **EC2A-5110**

- The symbols of mounted control units are as follows:

Pilot Light
 Pushbutton
 Selector Switch
 Buzzer
 Meter

EC2A Flameproof and Increased Safety Control Boxes

2, 3, 4, 5 Control Units x 2 Columns (With or Without Wiring)



• No. of terminals for wiring: 16 maximum

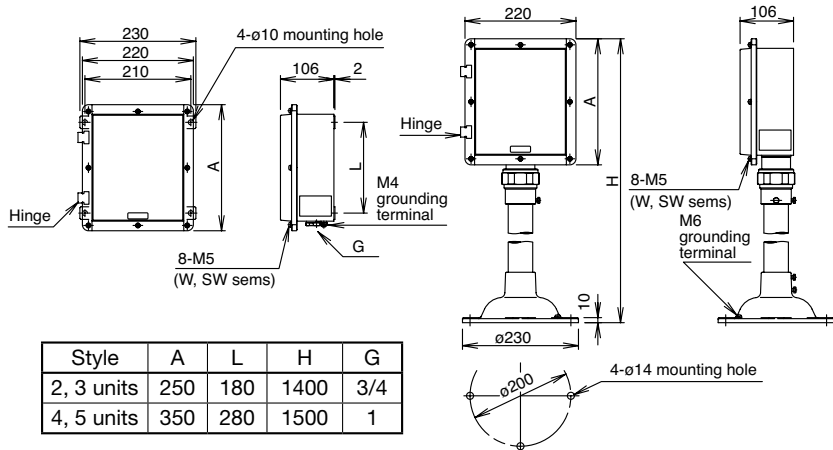

Style	A	L	H	G
2, 3 units	250	180	1400	3/4
4, 5 units	350	280	1500	1

• Weight (approx.)

Style	Wall Mount	Pole Mount
2, 3 Units	3.8 kg	9.3 kg
4, 5 Units	4.6 kg	10.4 kg

Control Unit Mounting Hole

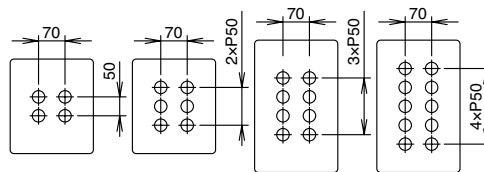

• 2 Control Units Standard Model Part No.

Package quantity: 1

Symbol		Mounted Control Units	Custom Assembled Control Box
		<ul style="list-style-type: none"> • 110V AC, Red lens • 110V AC, Green lens 	<ul style="list-style-type: none"> • Specify voltage and lens color. • Specify voltage and lens color.
Without Wiring	Wall Mount	EC2A-2201NF2N1	EC2A-2201NF□N0
	Pole Mount	EC2A-2201NSFN1	EC2A-2201NSFN0
With Wiring	Wall Mount	EC2A-2201NF2W1	EC2A-2201NF□W0
	Pole Mount	EC2A-2201NSFW1	EC2A-2201NSFW0
	Standard Wiring No.	⑥-1	Specify wiring diagram.
TIIS Type Test Approval No.		TC14280	

Symbol		Mounted Control Units	Custom Assembled Control Box
		<ul style="list-style-type: none"> • Flush, Momentary, 1NO-1NC contact Nameplate: ON • Flush, Momentary, 1NO-1NC contact Nameplate: OFF 	<ul style="list-style-type: none"> • Specify button shape and nameplate legend. • Specify button shape and nameplate legend.
Without Wiring	Wall Mount	EC2A-2202NF2N1	EC2A-2202NF□N0
	Pole Mount	EC2A-2202NSFN1	EC2A-2202NSFN0
With Wiring	Wall Mount	EC2A-2202NF2W1	EC2A-2202NF□W0
	Pole Mount	EC2A-2202NSFW1	EC2A-2202NSFW0
	Standard Wiring No.	⑥-2	Specify wiring diagram.
TIIS Type Test Approval No.		TC14280	

• 3 Control Units Standard Model Part No.

Package quantity: 1

Symbol		Mounted Control Units	Custom Assembled Control Box
		<ul style="list-style-type: none"> • Flush, Momentary, 1NO-1NC contact Nameplate: ON • Flush, Momentary, 1NO-1NC contact Nameplate: OFF • Knob operator, 2-position, Maintained, 1NO-1NC contact Nameplate: HAND-AUTO 	<ul style="list-style-type: none"> • Specify button shape and nameplate legend. • Specify button shape and nameplate legend. • Specify operator shape, no. of positions, and nameplate legend.
Without Wiring	Wall Mount	EC2A-3204NF2N1	EC2A-3204NF□N0
	Pole Mount	EC2A-3204NSFN1	EC2A-3204NSFN0
With Wiring	Wall Mount	EC2A-3204NF2W1	EC2A-3204NF□W0
	Pole Mount	EC2A-3204NSFW1	EC2A-3204NSFW0
	Standard Wiring No.	⑦-9	Specify wiring diagram.
TIIS Type Test Approval No.		TC14280	

Symbol		Mounted Control Units	Custom Assembled Control Box
		<ul style="list-style-type: none"> • 110V AC, Red lens • Flush, Momentary, 1NO-1NC contact Nameplate: ON • Flush, Momentary, 1NO-1NC contact Nameplate: OFF 	<ul style="list-style-type: none"> • Specify voltage and lens color. • Specify button shape and nameplate legend. • Specify button shape and nameplate legend.
Without Wiring	Wall Mount	EC2A-3210NF2N1	EC2A-3210NF□N0
	Pole Mount	EC2A-3210NSFN1	EC2A-3210NSFN0
With Wiring	Wall Mount	EC2A-3210NF2W1	EC2A-3210NF□W0
	Pole Mount	EC2A-3210NSFW1	EC2A-3210NSFW0
	Standard Wiring No.	⑦-2	Specify wiring diagram.
TIIS Type Test Approval No.		TC14280	

EC2A Flameproof and Increased Safety Control Boxes

Symbol		Mounted Control Units	Custom Assembled Control Box																
		<ul style="list-style-type: none"> Specify capacity and scale. Flush, Momentary, 1NO-1NC contact Nameplate: ON Flush, Momentary, 1NO-1NC contact Nameplate: OFF 	<ul style="list-style-type: none"> Specify capacity and scale. Specify button shape and nameplate legend. Specify button shape and nameplate legend. 																
		<table border="1"> <tr> <td>Without Wiring</td> <td>Wall Mount</td> <td>EC2A-3252NF2N1</td> <td>EC2A-3252NF□N0</td> </tr> <tr> <td></td> <td>Pole Mount</td> <td>EC2A-3252NSFN1</td> <td>EC2A-3252NSFN0</td> </tr> <tr> <td rowspan="3">With Wiring</td> <td>Wall Mount</td> <td>EC2A-3252NF2W1</td> <td>EC2A-3252NF□W0</td> </tr> <tr> <td>Pole Mount</td> <td>EC2A-3252NSFW1</td> <td>EC2A-3252NSFW0</td> </tr> <tr> <td>Standard Wiring No.</td> <td>⑦-5</td> <td>Specify wiring diagram.</td> </tr> </table>	Without Wiring	Wall Mount	EC2A-3252NF2N1	EC2A-3252NF□N0		Pole Mount	EC2A-3252NSFN1	EC2A-3252NSFN0	With Wiring	Wall Mount	EC2A-3252NF2W1	EC2A-3252NF□W0	Pole Mount	EC2A-3252NSFW1	EC2A-3252NSFW0	Standard Wiring No.	⑦-5
Without Wiring	Wall Mount	EC2A-3252NF2N1	EC2A-3252NF□N0																
	Pole Mount	EC2A-3252NSFN1	EC2A-3252NSFN0																
With Wiring	Wall Mount	EC2A-3252NF2W1	EC2A-3252NF□W0																
	Pole Mount	EC2A-3252NSFW1	EC2A-3252NSFW0																
	Standard Wiring No.	⑦-5	Specify wiring diagram.																
TIIS Type Test Approval No.		TC14280																	

Symbol		Mounted Control Units			Custom Assembled Control Box																								
		<ul style="list-style-type: none"> Specify capacity and scale. 110V AC, Red lens Knob operator, 2-position, Maintained, 1NO-1NC contact Nameplate: OFF-ON 	<ul style="list-style-type: none"> Specify capacity and scale. 220V AC, Red lens Knob operator, 2-position, Maintained, 1NO-1NC contact Nameplate: OFF-ON 	<ul style="list-style-type: none"> Specify capacity and scale. 24V DC, Red lens Knob operator, 2-position, Maintained, 1NO-1NC contact Nameplate: OFF-ON 	<ul style="list-style-type: none"> Specify capacity and scale. Specify voltage and lens color. Specify operator shape, no. of positions, and nameplate legend. 																								
		<table border="1"> <tr> <td>Without Wiring</td> <td>Wall Mount</td> <td>EC2A-3257NF2N1</td> <td>EC2A-3257NF2N2</td> <td>EC2A-3257NF2N3</td> <td>EC2A-3257NF□N0</td> </tr> <tr> <td></td> <td>Pole Mount</td> <td>EC2A-3257NSFN1</td> <td>EC2A-3257NSFN2</td> <td>EC2A-3257NSFN3</td> <td>EC2A-3257NSFN0</td> </tr> <tr> <td rowspan="3">With Wiring</td> <td>Wall Mount</td> <td>EC2A-3257NF2W1</td> <td>EC2A-3257NF2W2</td> <td>EC2A-3257NF2W3</td> <td>EC2A-3257NF□W0</td> </tr> <tr> <td>Pole Mount</td> <td>EC2A-3257NSFW1</td> <td>EC2A-3257NSFW2</td> <td>EC2A-3257NSFW3</td> <td>EC2A-3257NSFW0</td> </tr> <tr> <td>Standard Wiring No.</td> <td>⑦-3</td> <td>⑦-3</td> <td>⑦-3</td> <td>Specify wiring diagram.</td> </tr> </table>	Without Wiring	Wall Mount	EC2A-3257NF2N1	EC2A-3257NF2N2	EC2A-3257NF2N3	EC2A-3257NF□N0		Pole Mount	EC2A-3257NSFN1	EC2A-3257NSFN2	EC2A-3257NSFN3	EC2A-3257NSFN0	With Wiring	Wall Mount	EC2A-3257NF2W1	EC2A-3257NF2W2	EC2A-3257NF2W3	EC2A-3257NF□W0	Pole Mount	EC2A-3257NSFW1	EC2A-3257NSFW2	EC2A-3257NSFW3	EC2A-3257NSFW0	Standard Wiring No.	⑦-3	⑦-3	⑦-3
Without Wiring	Wall Mount	EC2A-3257NF2N1	EC2A-3257NF2N2	EC2A-3257NF2N3	EC2A-3257NF□N0																								
	Pole Mount	EC2A-3257NSFN1	EC2A-3257NSFN2	EC2A-3257NSFN3	EC2A-3257NSFN0																								
With Wiring	Wall Mount	EC2A-3257NF2W1	EC2A-3257NF2W2	EC2A-3257NF2W3	EC2A-3257NF□W0																								
	Pole Mount	EC2A-3257NSFW1	EC2A-3257NSFW2	EC2A-3257NSFW3	EC2A-3257NSFW0																								
	Standard Wiring No.	⑦-3	⑦-3	⑦-3	Specify wiring diagram.																								
TIIS Type Test Approval No.		TC14280																											

• 4 Control Units Standard Model Part No.

Package quantity: 1

Symbol		Mounted Control Units	Custom Assembled Control Box																
		<ul style="list-style-type: none"> 110V AC, Red lens 110V AC, Green lens Flush, Momentary, 1NO-1NC contact Nameplate: ON Flush, Momentary, 1NO-1NC contact Nameplate: OFF 	<ul style="list-style-type: none"> Specify voltage and lens color. Specify voltage and lens color. Specify button shape and nameplate legend. Specify button shape and nameplate legend. 																
		<table border="1"> <tr> <td>Without Wiring</td> <td>Wall Mount</td> <td>EC2A-4210NF3N1</td> <td>EC2A-4210NF□N0</td> </tr> <tr> <td></td> <td>Pole Mount</td> <td>EC2A-4210NSFN1</td> <td>EC2A-4210NSFN0</td> </tr> <tr> <td rowspan="3">With Wiring</td> <td>Wall Mount</td> <td>EC2A-4210NF3W1</td> <td>EC2A-4210NF□W0</td> </tr> <tr> <td>Pole Mount</td> <td>EC2A-4210NSFW1</td> <td>EC2A-4210NSFW0</td> </tr> <tr> <td>Standard Wiring No.</td> <td>⑧-1</td> <td>Specify wiring diagram.</td> </tr> </table>	Without Wiring	Wall Mount	EC2A-4210NF3N1	EC2A-4210NF□N0		Pole Mount	EC2A-4210NSFN1	EC2A-4210NSFN0	With Wiring	Wall Mount	EC2A-4210NF3W1	EC2A-4210NF□W0	Pole Mount	EC2A-4210NSFW1	EC2A-4210NSFW0	Standard Wiring No.	⑧-1
Without Wiring	Wall Mount	EC2A-4210NF3N1	EC2A-4210NF□N0																
	Pole Mount	EC2A-4210NSFN1	EC2A-4210NSFN0																
With Wiring	Wall Mount	EC2A-4210NF3W1	EC2A-4210NF□W0																
	Pole Mount	EC2A-4210NSFW1	EC2A-4210NSFW0																
	Standard Wiring No.	⑧-1	Specify wiring diagram.																
TIIS Type Test Approval No.		TC14281																	

Symbol		Mounted Control Units	Custom Assembled Control Box																
		<ul style="list-style-type: none"> 110V AC, Red lens Flush, Momentary, 1NO-1NC contact Nameplate: ON Flush, Momentary, 1NO-1NC contact Nameplate: OFF Knob operator, 2-position, Maintained, 1NO-1NC contact Nameplate: HAND-AUTO 	<ul style="list-style-type: none"> Specify voltage and lens color. Specify button shape and nameplate legend. Specify button shape and nameplate legend. Specify operator shape, no. of positions, and nameplate legend. 																
		<table border="1"> <tr> <td>Without Wiring</td> <td>Wall Mount</td> <td>EC2A-4213NF3N1</td> <td>EC2A-4213NF□N0</td> </tr> <tr> <td></td> <td>Pole Mount</td> <td>EC2A-4213NSFN1</td> <td>EC2A-4213NSFN0</td> </tr> <tr> <td rowspan="3">With Wiring</td> <td>Wall Mount</td> <td>EC2A-4213NF3W1</td> <td>EC2A-4213NF□W0</td> </tr> <tr> <td>Pole Mount</td> <td>EC2A-4213NSFW1</td> <td>EC2A-4213NSFW0</td> </tr> <tr> <td>Standard Wiring No.</td> <td>⑧-3</td> <td>Specify wiring diagram.</td> </tr> </table>	Without Wiring	Wall Mount	EC2A-4213NF3N1	EC2A-4213NF□N0		Pole Mount	EC2A-4213NSFN1	EC2A-4213NSFN0	With Wiring	Wall Mount	EC2A-4213NF3W1	EC2A-4213NF□W0	Pole Mount	EC2A-4213NSFW1	EC2A-4213NSFW0	Standard Wiring No.	⑧-3
Without Wiring	Wall Mount	EC2A-4213NF3N1	EC2A-4213NF□N0																
	Pole Mount	EC2A-4213NSFN1	EC2A-4213NSFN0																
With Wiring	Wall Mount	EC2A-4213NF3W1	EC2A-4213NF□W0																
	Pole Mount	EC2A-4213NSFW1	EC2A-4213NSFW0																
	Standard Wiring No.	⑧-3	Specify wiring diagram.																
TIIS Type Test Approval No.		TC14281																	

EC2A Flameproof and Increased Safety Control Boxes

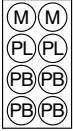
Symbol		Mounted Control Units	Custom Assembled Control Box
		<ul style="list-style-type: none"> Specify capacity and scale. 110V AC, Red lens Flush, Momentary, 1NO-1NC contact Nameplate: ON Flush, Momentary, 1NO-1NC contact Nameplate: OFF 	<ul style="list-style-type: none"> Specify capacity and scale. Specify voltage and lens color. Specify button shape and nameplate legend. Specify button shape and nameplate legend.
Without Wiring	Wall Mount	EC2A-4250NF3N1	EC2A-4250NF□N0
	Pole Mount	EC2A-4250NSFN1	EC2A-4250NSFN0
With Wiring	Wall Mount	EC2A-4250NF3W1	EC2A-4250NF□W0
	Pole Mount	EC2A-4250NSFW1	EC2A-4250NSFW0
	Standard Wiring No.	⑨-2	Specify wiring diagram.
TIIS Type Test Approval No.		TC14281	

• 5 Control Units Standard Model Part No.

Package quantity: 1

Symbol		Mounted Control Units				Custom Assembled Control Box
		<ul style="list-style-type: none"> 110V AC, Red lens 110V AC, Green lens Flush, Momentary, 1NO-1NC contact Nameplate: FORWARD Flush, Momentary, 1NO-1NC contact Nameplate: REVERSE Flush, Momentary, 1NO-1NC contact Nameplate: STOP 	<ul style="list-style-type: none"> 220V AC, Red lens 220V AC, Green lens Flush, Momentary, 1NO-1NC contact Nameplate: FORWARD Flush, Momentary, 1NO-1NC contact Nameplate: REVERSE Flush, Momentary, 1NO-1NC contact Nameplate: STOP 	<ul style="list-style-type: none"> 24V DC, Red lens 24V DC, Green lens Flush, Momentary, 1NO-1NC contact Nameplate: FORWARD Flush, Momentary, 1NO-1NC contact Nameplate: REVERSE Flush, Momentary, 1NO-1NC contact Nameplate: STOP 	<ul style="list-style-type: none"> 110V AC, Red lens 110V AC, Green lens Extended, Momentary, 1NO-1NC contact Nameplate: FORWARD Button color: Black Extended, Momentary, 1NO-1NC contact Nameplate: REVERSE Button color: Black Extended, Momentary, 1NO-1NC contact Nameplate: STOP Button color: Red 	<ul style="list-style-type: none"> Specify voltage and lens color. Specify voltage and lens color. Specify button shape and nameplate legend. Specify button shape and nameplate legend. Specify button shape and nameplate legend.
Without Wiring	Wall Mount	EC2A-5210NF3N1	EC2A-5210NF3N2	EC2A-5210NF3N3	EC2A-5210NF3N4	EC2A-5210NF□N0
	Pole Mount	EC2A-5210NSFN1	EC2A-5210NSFN2	EC2A-5210NSFN3	EC2A-5210NSFN4	EC2A-5210NSFN0
With Wiring	Wall Mount	EC2A-5210NF3W1	EC2A-5210NF3W2	EC2A-5210NF3W3	EC2A-5210NF3W4	EC2A-5210NF□W0
	Pole Mount	EC2A-5210NSFW1	EC2A-5210NSFW2	EC2A-5210NSFW3	EC2A-5210NSFW4	EC2A-5210NSFW0
	Standard Wiring No.	⑨-1	⑨-1	⑨-1	⑨-1	Specify wiring diagram.
TIIS Type Test Approval No.		TC14281				

Symbol		Mounted Control Units				Custom Assembled Control Box
		<ul style="list-style-type: none"> 110V AC, Red lens 110V AC, Green lens Flush, Momentary, 1NO-1NC contact Nameplate: ON Flush, Momentary, 1NO-1NC contact Nameplate: OFF Knob operator, 2-position, Maintained, 1NO-1NC contact Nameplate: HAND-AUTO 	<ul style="list-style-type: none"> 220V AC, Red lens 220V AC, Green lens Flush, Momentary, 1NO-1NC contact Nameplate: ON Flush, Momentary, 1NO-1NC contact Nameplate: OFF Knob operator, 2-position, Maintained, 1NO-1NC contact Nameplate: HAND-AUTO 	<ul style="list-style-type: none"> 24V DC, Red lens 24V DC, Green lens Flush, Momentary, 1NO-1NC contact Nameplate: ON Flush, Momentary, 1NO-1NC contact Nameplate: OFF Knob operator, 2-position, Maintained, 1NO-1NC contact Nameplate: HAND-AUTO 	<ul style="list-style-type: none"> 110V AC, Red lens 110V AC, Green lens Extended, Momentary, 1NO-1NC contact Nameplate: ON Button color: Black Extended, Momentary, 1NO-1NC contact Nameplate: OFF Button color: Red Knob operator, 2-position, Maintained, 1NO-1NC contact Nameplate: HAND-AUTO 	<ul style="list-style-type: none"> Specify voltage and lens color. Specify voltage and lens color. Specify button shape and nameplate legend. Specify button shape and nameplate legend. Specify operator shape, no. of positions, and nameplate legend.
Without Wiring	Wall Mount	EC2A-5213NF3N1	EC2A-5213NF3N2	EC2A-5213NF3N3	EC2A-5213NF3N4	EC2A-5213NF□N0
	Pole Mount	EC2A-5213NSFN1	EC2A-5213NSFN2	EC2A-5213NSFN3	EC2A-5213NSFN4	EC2A-5213NSFN0
With Wiring	Wall Mount	EC2A-5213NF3W1	EC2A-5213NF3W2	EC2A-5213NF3W3	EC2A-5213NF3W4	EC2A-5213NF□W0
	Pole Mount	EC2A-5213NSFW1	EC2A-5213NSFW2	EC2A-5213NSFW3	EC2A-5213NSFW4	EC2A-5213NSFW0
	Standard Wiring No.	⑨-2	⑨-2	⑨-2	⑨-2	Specify wiring diagram.
TIIS Type Test Approval No.		TC14281				

EC2A Flameproof and Increased Safety Control Boxes

Symbol		Mounted Control Units	Custom Assembled Control Box
		<ul style="list-style-type: none"> Specify capacity and scale. 110V AC, Red lens 110V AC, Green lens Flush, Momentary, 1NO-1NC contact Nameplate: ON Flush, Momentary, 1NO-1NC contact Nameplate: OFF 	<ul style="list-style-type: none"> Specify capacity and scale. Specify voltage and lens color. Specify voltage and lens color. Specify button shape and nameplate legend. Specify button shape and nameplate legend.
Without Wiring	Wall Mount	EC2A-5250NF3N1	EC2A-5250NF□N0
	Pole Mount	EC2A-5250NSFN1	EC2A-5250NSFN0
With Wiring	Wall Mount	EC2A-5250NF3W1	EC2A-5250NF□W0
	Pole Mount	EC2A-5250NSFW1	EC2A-5250NSFW0
	Standard Wiring No.	⑨-3	Specify wiring diagram.
TIIS Type Test Approval No.		TC14281	

[Standard Control Box]

- When required mounted units, control unit nameplate, and lead-in fitting are found in the standard control boxes, specify the Part No. to order the standard control boxes. When ordering a control box with meters, specify the capacity and scale of the meters. For Ordering Information, see page 33.
- For control unit specifications, see pages 24 to 26. For cable lead-in fitting specifications, see page 26. For control unit nameplate specifications, see page 28.
- Pushbuttons without color code designation are supplied with black, green, and red pushbutton color caps.
- If control unit nameplates are not required on standard control boxes, add "0" after the Part No.

Example: **EC2A-5210NF3W10**

- For standard wiring diagrams, see pages 22 and 23.

[Custom Assembled Control Box]





- If required control units, control unit nameplates, and cable lead-in fittings are not available with standard control boxes, specify the Type Numbers and codes of the required control box, control units, control unit nameplates, and cable lead-in fittings. For Ordering Information, see page 34.
- For control unit specifications, see pages 24 to 26. For cable lead-in fitting specifications, see page 26. For control unit nameplate specifications, see page 28.
- Specify a lead-in fitting code shown on page 26 in place of □ in the Part No. of the control box.
- When wiring is required, specify the wiring diagram.

[Remarks]

- Up to 9 letters of the Part No. can be indicated on the housing.

Example: **EC2A-5210**

- The symbols of mounted control units are as follows:

 Pilot Light
  Pushbutton
  Selector Switch
 Buzzer
  Meter

EC2A Flameproof and Increased Safety Control Boxes

2, 3, 4, 5 Control Units x 3 Columns (With or Without Wiring)



Wall Mount



Pole Mount

- No. of terminals for wiring: 24 maximum

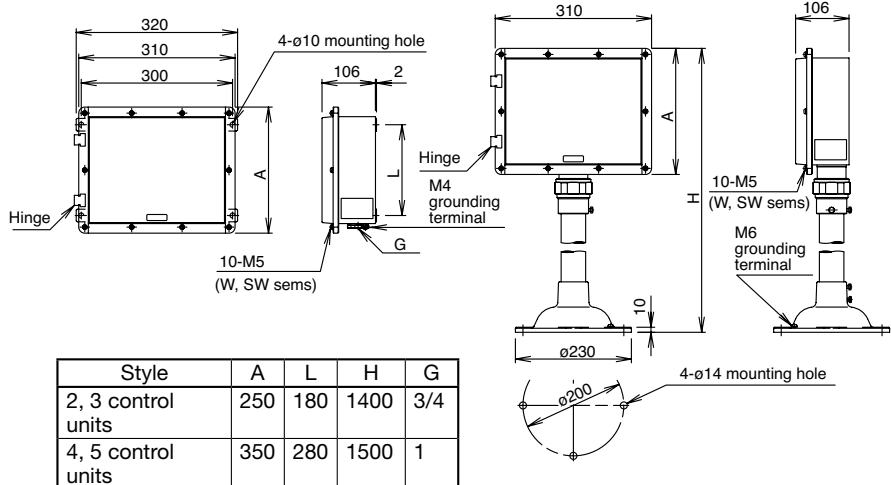

Style	A	L	H	G
2, 3 control units	250	180	1400	3/4
4, 5 control units	350	280	1500	1

- Weight (approx.)

Style	Wall Mount	Pole Mount
2, 3 control units	4.8 kg	10.6 kg
4, 5 control units	6.5 kg	12.2 kg

Control Unit Mounting Hole

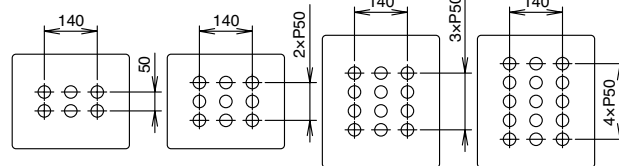

• 2 Control Units Standard Model Part No.

Symbol		Mounted Control Units	Custom Assembled Control Box
		<ul style="list-style-type: none"> • 110V AC, Red lens • 110V AC, Green lens 	<ul style="list-style-type: none"> • Specify voltage and lens color. • Specify voltage and lens color.
Without Wiring	Wall Mount	EC2A-2301NF2N1	EC2A-2301NF□N0
	Pole Mount	EC2A-2301NSFN1	EC2A-2301NSFN0
With Wiring	Wall Mount	EC2A-2301NF2W1	EC2A-2301NF□W0
	Pole Mount	EC2A-2301NSFW1	EC2A-2301NSFW0
	Standard Wiring No.	②-1	Specify wiring diagram.
TIIS Type Test Approval No.		TC14282	

Package quantity: 1

Symbol		Mounted Control Units	Custom Assembled Control Box
		<ul style="list-style-type: none"> • Flush, Momentary, 1NO-1NC contact Nameplate: ON • Flush, Momentary, 1NO-1NC contact Nameplate: OFF 	<ul style="list-style-type: none"> • Specify button shape and nameplate legend. • Specify button shape and nameplate legend.
Without Wiring	Wall Mount	EC2A-2302NF2N1	EC2A-2302NF□N0
	Pole Mount	EC2A-2302NSFN1	EC2A-2302NSFN0
With Wiring	Wall Mount	EC2A-2302NF2W1	EC2A-2302NF□W0
	Pole Mount	EC2A-2302NSFW1	EC2A-2302NSFW0
	Standard Wiring No.	②-2	Specify wiring diagram.
TIIS Type Test Approval No.		TC14282	

• 3 Control Units Standard Model Part No.

Symbol		Mounted Control Units	Custom Assembled Control Box
		<ul style="list-style-type: none"> • 110V AC, Red lens • Flush, Momentary, 1NO-1NC contact Nameplate: ON • Flush, Momentary, 1NO-1NC contact Nameplate: OFF 	<ul style="list-style-type: none"> • Specify voltage and lens color. • Specify button shape and nameplate legend. • Specify button shape and nameplate legend.
Without Wiring	Wall Mount	EC2A-3310NF2N1	EC2A-3310NF□N0
	Pole Mount	EC2A-3310NSFN1	EC2A-3310NSFN0
With Wiring	Wall Mount	EC2A-3310NF2W1	EC2A-3310NF□W0
	Pole Mount	EC2A-3310NSFW1	EC2A-3310NSFW0
	Standard Wiring No.	⑦-2	Specify wiring diagram.
TIIS Type Test Approval No.		TC14282	

Package quantity: 1

Symbol		Mounted Control Units	Custom Assembled Control Box
		<ul style="list-style-type: none"> • Specify capacity and scale. • Flush, Momentary, 1NO-1NC contact Nameplate: ON • Flush, Momentary, 1NO-1NC contact Nameplate: OFF 	<ul style="list-style-type: none"> • Specify capacity and scale. • Specify button shape and nameplate legend. • Specify button shape and nameplate legend.
Without Wiring	Wall Mount	EC2A-3352NF2N1	EC2A-3352NF□N0
	Pole Mount	EC2A-3352NSFN1	EC2A-3352NSFN0
With Wiring	Wall Mount	EC2A-3352NF2W1	EC2A-3352NF□W0
	Pole Mount	EC2A-3352NSFW1	EC2A-3352NSFW0
	Standard Wiring No.	⑦-5	Specify wiring diagram.
TIIS Type Test Approval No.		TC14282	

EC2A Flameproof and Increased Safety Control Boxes

Symbol		Mounted Control Units			Custom Assembled Control Box
		<ul style="list-style-type: none"> Specify capacity and scale. 110V AC, Red lens Knob operator, 2-position, Maintained, 1NO-1NC contact Nameplate: OFF-ON 	<ul style="list-style-type: none"> Specify capacity and scale. 220V AC, Red lens Knob operator, 2-position, Maintained, 1NO-1NC contact Nameplate: OFF-ON 	<ul style="list-style-type: none"> Specify capacity and scale. 24V DC, Red lens Knob operator, 2-position, Maintained, 1NO-1NC contact Nameplate: OFF-ON 	<ul style="list-style-type: none"> Specify capacity and scale. Specify voltage and lens color. Specify operator shape, no. of positions, and nameplate legend.
Without Wiring	Wall Mount	EC2A-3357NF2N1	EC2A-3357NF2N2	EC2A-3357NF2N3	EC2A-3357NF□N0
	Pole Mount	EC2A-3357NSFN1	EC2A-3357NSFN2	EC2A-3357NSFN3	EC2A-3357NSFN0
With Wiring	Wall Mount	EC2A-3357NF2W1	EC2A-3357NF2W2	EC2A-3357NF2W3	EC2A-3357NF□W0
	Pole Mount	EC2A-3357NSFW1	EC2A-3357NSFW2	EC2A-3357NSFW3	EC2A-3357NSFW0
	Standard Wiring No.	⑦-3	⑦-3	⑦-3	Specify wiring diagram.
TIIS Type Test Approval No.		TC14280			

• 4 Control Units Standard Model Part No.

Package quantity: 1

Symbol		Mounted Control Units	Custom Assembled Control Box
		<ul style="list-style-type: none"> 110V AC, Red lens 110V AC, Green lens Flush, Momentary, 1NO-1NC contact Nameplate: ON Flush, Momentary, 1NO-1NC contact Nameplate: OFF 	<ul style="list-style-type: none"> Specify voltage and lens color. Specify voltage and lens color. Specify button shape and nameplate legend. Specify button shape and nameplate legend.
Without Wiring	Wall Mount	EC2A-4310NF3N1	EC2A-4310NF□N0
	Pole Mount	EC2A-4310NSFN1	EC2A-4310NSFN0
With Wiring	Wall Mount	EC2A-4310NF3W1	EC2A-4310NF□W0
	Pole Mount	EC2A-4310NSFW1	EC2A-4310NSFW0
	Standard Wiring No.	⑧-1	Specify wiring diagram.
TIIS Type Test Approval No.		TC14283	

Symbol		Mounted Control Units	Custom Assembled Control Box
		<ul style="list-style-type: none"> 110V AC, Red lens Flush, Momentary, 1NO-1NC contact Nameplate: ON Flush, Momentary, 1NO-1NC contact Nameplate: OFF Knob operator, 2-position, Maintained, 1NO-1NC contact Nameplate: HAND-AUTO 	<ul style="list-style-type: none"> Specify voltage and lens color. Specify button shape and nameplate legend. Specify button shape and nameplate legend. Specify operator shape, no. of positions, and nameplate legend.
Without Wiring	Wall Mount	EC2A-4313NF3N1	EC2A-4313NF□N0
	Pole Mount	EC2A-4313NSFN1	EC2A-4313NSFN0
With Wiring	Wall Mount	EC2A-4313NF3W1	EC2A-4313NF□W0
	Pole Mount	EC2A-4313NSFW1	EC2A-4313NSFW0
	Standard Wiring No.	⑧-3	Specify wiring diagram.
TIIS Type Test Approval No.		TC14283	

Symbol		Mounted Control Units	Custom Assembled Control Box
		<ul style="list-style-type: none"> Specify capacity and scale. 110V AC, Green lens Flush, Momentary, 1NO-1NC contact Nameplate: ON Flush, Momentary, 1NO-1NC contact Nameplate: OFF 	<ul style="list-style-type: none"> Specify capacity and scale. Specify voltage and lens color. Specify button shape and nameplate legend. Specify button shape and nameplate legend.
Without Wiring	Wall Mount	EC2A-4350NF3N1	EC2A-4350NF□N0
	Pole Mount	EC2A-4350NSFN1	EC2A-4350NSFN0
With Wiring	Wall Mount	EC2A-4350NF3W1	EC2A-4350NF□W0
	Pole Mount	EC2A-4350NSFW1	EC2A-4350NSFW0
	Standard Wiring No.	⑧-2	Specify wiring diagram.
TIIS Type Test Approval No.		TC14283	

EC2A Flameproof and Increased Safety Control Boxes

• 5 Control Units Standard Model Part No.

Package quantity: 1

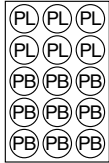
Symbol		Mounted Control Units				Custom Assembled Control Box
		<ul style="list-style-type: none"> • 110V AC, Red lens • 110V AC, Green lens • Flush, Momentary, 1NO-1NC contact Nameplate: FORWARD • Flush, Momentary, 1NO-1NC contact Nameplate: REVERSE • Flush, Momentary, 1NO-1NC contact Nameplate: STOP 	<ul style="list-style-type: none"> • 220V AC, Red lens • 220V AC, Green lens • Flush, Momentary, 1NO-1NC contact Nameplate: FORWARD • Flush, Momentary, 1NO-1NC contact Nameplate: REVERSE • Flush, Momentary, 1NO-1NC contact Nameplate: STOP 	<ul style="list-style-type: none"> • 24V DC, Red lens • 24V DC, Green lens • Flush, Momentary, 1NO-1NC contact Nameplate: FORWARD • Flush, Momentary, 1NO-1NC contact Nameplate: REVERSE • Flush, Momentary, 1NO-1NC contact Nameplate: STOP 	<ul style="list-style-type: none"> • 110V AC, Red lens • 110V AC, Green lens • Extended, Momentary, 1NO-1NC contact Nameplate: FORWARD Button color: Black • Extended, Momentary, 1NO-1NC contact Nameplate: REVERSE Button color: Red • Extended, Momentary, 1NO-1NC contact Nameplate: STOP Button color: Red 	<ul style="list-style-type: none"> • Specify voltage and lens color. • Specify voltage and lens color. • Specify button shape and nameplate legend. • Specify button shape and nameplate legend. • Specify button shape and nameplate legend.
Without Wiring	Wall Mount	EC2A-5310NF3N1	EC2A-5310NF3N2	EC2A-5310NF3N3	EC2A-5310NF3N4	EC2A-5310NF□N0
	Pole Mount	EC2A-5310NSFN1	EC2A-5310NSFN2	EC2A-5310NSFN3	EC2A-5310NSFN4	EC2A-5310NSFN0
With Wiring	Wall Mount	EC2A-5310NF3W1	EC2A-5310NF3W2	EC2A-5310NF3W3	EC2A-5310NF3W4	EC2A-5310NF□W0
	Pole Mount	EC2A-5310NSFW1	EC2A-5310NSFW2	EC2A-5310NSFW3	EC2A-5310NSFW4	EC2A-5310NSFW0
	Standard Wiring No.	⑨-1	⑨-1	⑨-1	⑨-1	Specify wiring diagram.
TIIS Type Test Approval No.		TC14283				

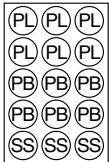
Symbol		Mounted Control Units				Custom Assembled Control Box
		<ul style="list-style-type: none"> • 110V AC, Red lens • 110V AC, Green lens • Flush, Momentary, 1NO-1NC contact Nameplate: ON • Flush, Momentary, 1NO-1NC contact Nameplate: OFF • Knob operator, 2-position, Maintained, 1NO-1NC contact Nameplate: HAND-AUTO 	<ul style="list-style-type: none"> • 220V AC, Red lens • 220V AC, Green lens • Flush, Momentary, 1NO-1NC contact Nameplate: ON • Flush, Momentary, 1NO-1NC contact Nameplate: OFF • Knob operator, 2-position, Maintained, 1NO-1NC contact Nameplate: HAND-AUTO 	<ul style="list-style-type: none"> • 24V DC, Red lens • 24V DC, Green lens • Flush, Momentary, 1NO-1NC contact Nameplate: ON • Flush, Momentary, 1NO-1NC contact Nameplate: OFF • Knob operator, 2-position, Maintained, 1NO-1NC contact Nameplate: HAND-AUTO 	<ul style="list-style-type: none"> • 110V AC, Red lens • 110V AC, Green lens • Extended, Momentary, 1NO-1NC contact Nameplate: ON Button color: Black • Extended, Momentary, 1NO-1NC contact Nameplate: OFF Button color: Red • Knob operator, 2-position, Maintained, 1NO-1NC contact Nameplate: HAND-AUTO 	<ul style="list-style-type: none"> • Specify voltage and lens color. • Specify voltage and lens color. • Specify button shape and nameplate legend. • Specify button shape and nameplate legend. • Specify button shape and nameplate legend. • Specify operator shape, no. of positions, and nameplate legend.
Without Wiring	Wall Mount	EC2A-5313NF3N1	EC2A-5313NF3N2	EC2A-5313NF3N3	EC2A-5313NF3N4	EC2A-5313NF□N0
	Pole Mount	EC2A-5313NSFN1	EC2A-5313NSFN2	EC2A-5313NSFN3	EC2A-5313NSFN4	EC2A-5313NSFN0
With Wiring	Wall Mount	EC2A-5313NF3W1	EC2A-5313NF3W2	EC2A-5313NF3W3	EC2A-5313NF3W4	EC2A-5313NF□W0
	Pole Mount	EC2A-5313NSFW1	EC2A-5313NSFW2	EC2A-5313NSFW3	EC2A-5313NSFW4	EC2A-5313NSFW0
	Standard Wiring No.	⑨-2	⑨-2	⑨-2	⑨-2	Specify wiring diagram.
TIIS Type Test Approval No.		TC14283				

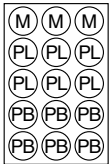
Symbol		Mounted Control Units	Custom Assembled Control Box
		<ul style="list-style-type: none"> • Specify capacity and scale. • 110V AC, Red lens • 110V AC, Green lens • Flush, Momentary, 1NO-1NC contact Nameplate: ON • Flush, Momentary, 1NO-1NC contact Nameplate: OFF 	<ul style="list-style-type: none"> • Specify capacity and scale. • Specify voltage and lens color. • Specify voltage and lens color. • Specify button shape and nameplate legend. • Specify button shape and nameplate legend.
Without Wiring	Wall Mount	EC2A-5350NF3N1	EC2A-5350NF□N0
	Pole Mount	EC2A-5350NSFN1	EC2A-5350NSFN0
With Wiring	Wall Mount	EC2A-5350NF3W1	EC2A-5350NF□W0
	Pole Mount	EC2A-5350NSFW1	EC2A-5350NSFW0
	Standard Wiring No.	⑨-3	Specify wiring diagram.
TIIS Type Test Approval No.		TC14283	

• Pushbuttons without color code designation are supplied with black, green, and red pushbutton color caps.

• If control unit nameplates are not required on standard control boxes, add "0" after the Part No.

Example: **EC2A-5310NF3W10**

• For standard wiring diagrams, see pages 22 and 23.

[Custom Assembled Control Box]

• If required control units, control unit nameplates, and cable lead-in fittings are not available with standard control boxes, specify the Type Numbers and codes of the required control box, control units, control unit nameplates, and cable lead-in fittings. For Ordering Information, see page 34.

• For control unit specifications, see pages 24 to 26. For cable lead-in fitting specifications, see page 26. For control unit nameplate specifications, see page 28.

• Specify a lead-in fitting code shown on page 26 in place of □ in the Part No. of the control box.





• When wiring is required, specify the wiring diagram.

[Remarks]

• Up to 9 letters of the Part No. can be indicated on the housing.

Example: **EC2A-5310**

• The symbols of mounted control units are as follows:

-  Pilot Light
-  Pushbutton
-  Selector Switch
-  Buzzer
-  Meter

[Standard Control Box]

• When required mounted units, control unit nameplate, and lead-in fitting are found in the standard control boxes, specify the Part No. to order the standard control boxes. When ordering a control box with meters, specify the capacity and scale of the meters. For Ordering Information, see page 33.

• For control unit specifications, see pages 24 to 26. For cable lead-in fitting specifications, see page 26. For control unit nameplate specifications, see page 28.

EC2A Flameproof and Increased Safety Control Boxes

Wall Mount

• Reducer (For Thick Steel Conduit)

Reducers installed to the control box are as follows:

- 1 column: 1 reducer
- 2 columns: 2 reducers
- 3 columns: 3 reducers

Standard Reducers

Control Box Type	Reducer Part No.	Applicable Conduit	Thread Size
1 column (1 to 3 control units)	EC9E-H32	22 mm	G3/4
2, 3 columns (2 or 3 control units)			
1, 2, 3 columns (4 or 5 control units)	EC9E-H43	28 mm	G1

Other reducers can also be installed.

Control Box Type	Reducer Part No.	Applicable Conduit	Thread Size
1 column (1 to 3 control units)	EC9E-H31	16 mm	G1/2
2, 3 columns (2 or 3 control units)	EC9E-H33	28 mm	G1
1, 2, 3 columns (4 or 5 control units)	EC9E-H42	22 mm	G3/4
	EC9E-H44	36 mm	G1 1/4

Pole Mount

• Packing Type Stand

A packing type cable lead-in method is used. Only one cable can be lead in. Three different packings are supplied for 1-, 2-, and 3-column control boxes.

Control Box Type	Packing Code	Cable Diameter D (mm)
1 column	R12	8 < D ≤ 12
	R16	12 < D ≤ 16
	R20	16 < D ≤ 20
2, 3 columns	R18	14 < D ≤ 18
	R22	18 < D ≤ 22
	R26	22 < D ≤ 26

• For wall mount control boxes, flameproof packing type lead-in fittings for rubber and plastic cables are also available.

Standard Wiring Diagram

When ordering control boxes with wiring, select a wiring diagram from the standard wiring diagrams shown below. When a required wiring diagram is not found in the standard wiring diagrams, specify your required wiring diagram.

1-column Control Box

• 1 control unit x 1 column (Pages 5 and 6)

No.	①-1	①-4	①-5	①-7	①-8
Wiring Diagram	1-PL-2	1-PB-2 3-○-4	SS HAND OFF ON 3-○-4 1-○-2	1-BZ-2	1-M-2

• 2 control units x 1 column (Pages 7 and 8)

No.	②-1	②-3	②-4	②-5	②-6
Wiring Diagram	1-PL-2 3-PL-4	1-PB-2 3-○-4 5-PB-6 7-○-8	1-PL-2 3-PB-4 5-○-6	1-PL-2 SS HAND OFF ON 5-○-6 3-○-4	1-BZ-2 3-PB-4 5-○-6

• 3 control units x 1 column (Pages 9 and 10)

No.	③-2	③-3	③-6	③-7	③-8	③-9	③-10
Wiring Diagram	1-PL-2 3-PB-4 4-○-5 6-PB-8 7-○-8	1-M-2 3-PL-4 SS HAND OFF ON 7-○-8 5-○-6	1-M-2 3-PB-4 4-○-5 6-PB-8 7-○-8	1-PB-2 3-○-4 5-PB-6 6-PB-7 8-○-8	1-PL-2 3-PL-4 5-PL-6	1-PL-2 3-PB-4 SS HAND OFF ON 7-○-8 5-○-6	1-BZ-2 3-PL-4 5-PB-6 7-○-8

• 4 control units x 1 column (Pages 11 and 12)

No.	④-1	④-2	④-3	④-4	④-5	④-6
Wiring Diagram	1-PL-2 3-PL-4 5-○-6 7-PB-8 8-○-8	1-M-2 3-PL-4 5-○-6 7-PB-8 8-○-8	1-PL-2 3-PL-4 5-PL-6 7-PL-8	1-M-2 3-○-4 5-PB-6 SS HAND OFF ON 7-○-8 6-○-8	1-PL-2 3-○-4 5-PB-6 SS HAND OFF ON 7-○-8 6-○-8	1-PB-2 3-PB-4 5-○-6 7-PB-8 8-○-8

EC2A Flameproof and Increased Safety Control Boxes

• 5 control units x 1 column (Pages 13 and 14)

No.	⑤-1	⑤-2	⑤-3	⑤-4	⑤-5	⑤-6
Wiring Diagram						

2- and 3-column Control Boxes

• 2 control units x 2 or 3 columns (Pages 15 and 19)

No.	⑥-1	⑥-2
Wiring Diagram		

• 3 control units x 2 or 3 columns (Pages 15, 16, 19, and 20)

No.	⑦-2	⑦-3	⑦-5	⑦-9
Wiring Diagram				

• 4 control units x 2 or 3 columns (Pages 16, 17, and 20)

No.	⑧-1	⑧-2	⑧-3
Wiring Diagram			

• 5 control units x 2 or 3 columns (Pages 17, 18, and 21)



No.	⑨-1	⑨-2	⑨-3
Wiring Diagram			

Note: The wiring diagrams show only for control units on the left-side column. The same wiring diagrams apply to control units on other columns. Terminal numbers are 11 to 20 for the left-side column, 21 to 30 for the center column, and 31 to 40 for the right-side column.

EC2A Flameproof and Increased Safety Control Boxes

Control Units (not sold separately)

• Pushbuttons

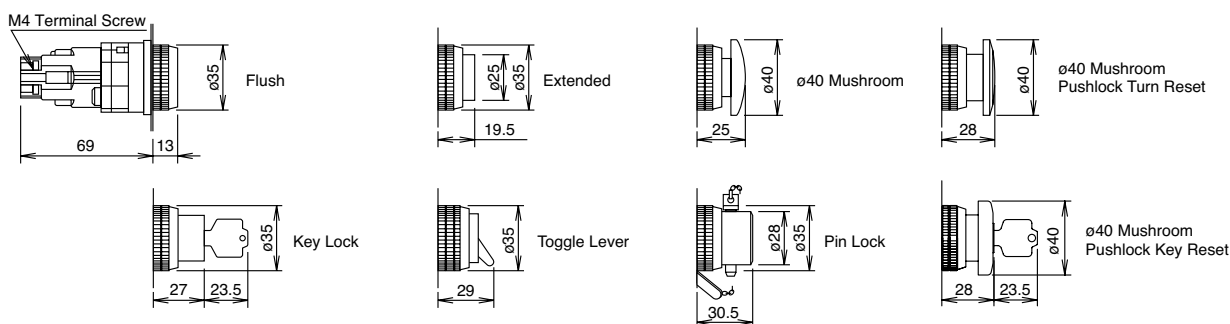

Appearance	Symbol	Operator Style and Operation Type	Part No.	Contact Arrangement	Contact Rating	Button Color Code ①	Weight (approx.)
		Flush, Momentary	EC9E-B111N	1NO-1NC	Rated thermal current: 10A Rated operating current 110V AC, 10A 220V AC, 6A 440V AC, 2A 24V DC, 8A 110V DC, 2.2A (resistive load)	BGR supplied	0.10 kg
		Extended, Momentary	EC9E-B211N①			B, G, R, Y	0.10 kg
		ø40 Mushroom, Momentary	EC9E-B311N①			B, G, R, Y	0.11 kg
		ø40 Mushroom, Pushlock Turn Reset	EC9E-BV311N①			R	0.12 kg
		Key Lock	EC9E-B511N			Metal	0.20 kg
		Toggle Lever	EC9E-B4T11N			Lever: Black	0.16 kg
		Pin Lock	EC9E-B8P11N			Metal	0.22 kg
		ø40 Mushroom, Pushlock Key Reset	EC9E-B3K11N			R	0.20 kg

Dimensions (mm)



- Button color code ①: B (black), G (green), R (red), Y (yellow)
- In addition to B, G, and R, flush pushbutton colors are also available in S (blue), W (white), and Y (yellow).
- In addition to B, G, R, and Y, extended pushbutton colors are also available in S (blue) and W (white).
- Contact arrangements are also available in 2NO and 2NC.

• Pilot Lights

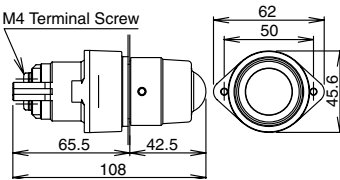
Appearance	Symbol	Input Type	Part No.	Operating Voltage	Built-in LED Lamp	Illumination Color Code②	Weight (approx.)	Dimensions (mm)
		Transformer	EC9E-L116DN②	100/110V AC 50/60Hz	LSTD-6②	A G PW R S Y	0.22 kg	
			EC9E-L126DN②	200/220V AC 50/60Hz				
		Full Voltage	EC9E-L166DN②	6V AC/DC	LSTD-6②	A G PW R S Y	0.16 kg	
			EC9E-L111DN②	12V AC/DC	LSTD-1②			
			EC9E-L122DN②	24V AC/DC	LSTD-2②			

- Illumination color code ②: A (amber), G (green), R (red), PW (pure white), S (blue), Y (yellow)
- Because LED illuminated pilot lights have small input currents, they may light on even when the power is off.
- See page 27 for built-in LED lamps.
- Use a pure white (PW) LED lamp for yellow illumination.

[Replacing LED Lamps]

Before replacing LED lamps, turn off the power to the pilot light. Use a hexagon wrench (Hex 2) to loosen two set screws in the lamp cover. Turn the lamp cover counterclockwise to remove. After replacing the LED lamp, install the lamp cover.

EC2A Flameproof and Increased Safety Control Boxes

• Selector Switches

Appearance	Dimensions (mm)	Terminal Screw M4			
			Knob Operator Weight: Approx. 0.15 kg	Lever Operator Weight: Approx. 0.15 kg	Key Operator Weight: Approx. 0.21 kg

Symbol	No. of Positions	Contact Code	Terminal No.	Operator Position		Operation Type	Operator Style and Part No.			Remarks		
				L	R		Knob Operator	Lever Operator	Key Operator			
SS	90° 2-position	11 (1NO-1NC)	1-2		●	L R	EC9E-S311N	EC9E-S3L11N	EC9E-S3K11N	Rated thermal current: 10A Rated operating current 110V AC, 10A 220V AC, 6A 440V AC, 2A 24V DC, 10A (resistive load)		
			3-4	●								
		20 (2NO)	1-2		●	L R	EC9E-S320N	EC9E-S3L20N	EC9E-S3K20N			
			3-4		●							
		11 (1NO-1NC)	1-2	●		L R	EC9E-S411N	EC9E-S4L11N	EC9E-S4K11N			
			3-4	●								
	20 (2NO)	1-2		●	L R	EC9E-S420N	EC9E-S4L20N	EC9E-S4K20N				
		3-4		●								
	45° 3-position	11 (1NO-1NC)			L	C	R	L C R	EC9E-S111N		EC9E-S1L11N	EC9E-S1K11N
			1-2	●								
									EC9E-S211N		EC9E-S2L11N	EC9E-S2K11N
		1-2	●									
								EC9E-S211N	EC9E-S2L11N	EC9E-S2K11N		
3-4				●								
							EC9E-S211N	EC9E-S2L11N	EC9E-S2K11N			
3-4			●									

• Meters

Appearance	Symbol	Input	Part No.	Specifications	Weight (approx.)	Dimensions (mm)
	M	AC input meter (ammeter)	EC9F-M53A5N	Capacity: 5A Expansion scale: x3	0.3 kg	
			EC9F-M53A10N	Capacity: 10/5A Expansion scale: x3		
			EC9F-M13A10N	Capacity: 10/1A Expansion scale: x3		
			EC9F-M53A15N	Capacity: 15/5A Expansion scale: x3		
			EC9F-M13A15N	Capacity: 15/1A Expansion scale: x3		
			EC9F-M13A20N	Capacity: 20/1A Expansion scale: x3		
			EC9F-M53A30N	Capacity: 30/5A Expansion scale: x3		
			EC9F-M13A30N	Capacity: 30/1A Expansion scale: x3		
			EC9F-M53A50N	Capacity: 50/5A Expansion scale: x3		
			EC9F-M53A60N	Capacity: 60/5A Expansion scale: x3		
			EC9F-M53A75N	Capacity: 75/5A Expansion scale: x3		
			EC9F-M53A100N	Capacity: 100/5A Expansion scale: x3		
		EC9F-M53A150N	Capacity: 150/5A Expansion scale: x3			
		DC input meter	EC9F-M010VD-PER	0-10V DC Input Scale: 0 to 100%		
			EC9F-M010VD-60HZ	0-10V DC Input Scale: 0 to 60Hz		
			EC9F-M01MD-PER	0-10 mA DC Input Scale: 0 to 100%		
			EC9F-M01MD-60HZ	0-10 mA DC Input Scale: 0 to 60Hz		
			EC9F-M01MD-80HZ	0-10 mA DC Input Scale: 0 to 80Hz		
			EC9F-M420MD-PER	4-20 mA DC Input Scale: 0 to 100%		
			EC9F-M420MD-60HZ	4-20 mA DC Input Scale: 0 to 60Hz		

- Use a commercially available CT (current transformer) for all AC ammeters, and install the CT in a non-hazardous location.
- AC and DC ammeters other than listed above are also available upon request.

• Buzzers

Appearance	Symbol	Part No.	Rated Voltage (50/60Hz)	Sound Duration	Sound Volume (at 1m)	Power Consumption	Weight (approx.)	Dimensions (mm)
	BZ	EC9F-Z11N	110V AC	10 minutes	80 dB minimum	8 VA maximum	0.4 kg	
		EC9F-Z12N	220V AC					

EC2A Flameproof and Increased Safety Control Boxes

• Variable Resistors

Appearance	Symbol	Part No.	Rated Power	Resistance Range	Insulation Resistance	Weight (approx.)	Dimensions (mm)
		EC9E-R	1W, 2.5W (at 40°C)	1 to 10 kΩ Tolerance: ±10% Characteristics: Linear	100 MΩ minimum (500V DC)	0.45 kg	

• The variable resistor is available only on control boxes with wiring.

Cable Lead-in Fittings

Wall Mount Type

• Flameproof Packing Type Lead-in Fittings (Type HPN)

Used for leading in a rubber or plastic cable into the control box.
Code: H1 to H7



Material: Brass
Treatment: Nickel plating

A cable clamp is provided to protect the packing from external force. A conduit adaptor which has a parallel pipe thread is attached to connect a conduit. The conduit adaptor features a union coupling method for easy wiring.

Lead-in Fitting Part No.	Code		Cable Diameter R (mm)	Dimensions (mm)						Weight (approx.)
	Wall Mount	Pole Mount		A	B	C	D	H	L	
HPN21 R8	H1	S1	6 < R ≤ 8	38	36	G3/4	G1/2 (16)	22	67 to 70.5	0.45 kg
HPN21 R10	H2	S2	8 < R ≤ 10							
HPN21 R12	H3	S3	10 < R ≤ 12							
HPN22 R14	H4	S4	12 < R ≤ 14	42	40	G3/4	G3/4 (22)	22	67 to 70.5	0.5 kg
HPN22 R16	H5	S5	14 < R ≤ 16							
HPN32 R14	H8	-	12 < R ≤ 14	42	40	G1	G3/4 (22)	22	67 to 70.5	0.55 kg
HPN32 R16	H9	-	14 < R ≤ 16							
HPN33 R18	H6	S6	16 < R ≤ 18	53	50	G1	G1(28)	22	77.5 to 81	0.88 kg
HPN33 R20	H7	S7	18 < R ≤ 20							
HPN44 R23	-	-	20 < R ≤ 23	61	58	G11/4	G11/4 (36)	22	80.5 to 84	1.15 kg
HPN44 R26	-	-	23 < R ≤ 26							

Note:

- The values in () for D indicate the nominal sizes.
- Use of flexible metal conduit is recommended for protecting cables.
- Non-standard cable lead-in fittings may require additional tooling.

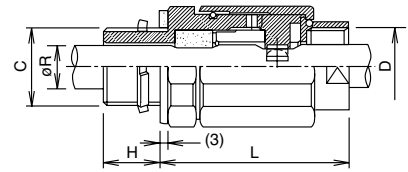
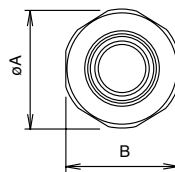

Pole Mount Type

• Packing Type Lead-in Fittings

[Standard Provision] Code: SF

Used for leading in a rubber or plastic cable into the control box. One-column boxes are supplied with three different-size packings (ø8 to ø12, ø12 to ø16, and ø16 to ø20) to connect cables of ø8 to ø20 in diameter. Two- and three-column boxes are supplied with three different-size packings (ø14 to ø18, ø18 to ø22, and ø22 to ø26) to connect cables of ø14 to ø26 in diameter.

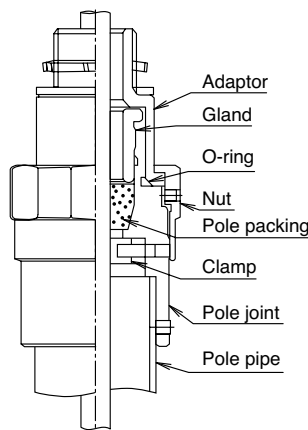





Wiring Construction

- Observe the laws and regulations in each country concerning wiring construction.
- Use cable wiring or metal conduit wiring for installation in hazardous locations. If foreign objects or water may enter the box, install a sealing fitting near the cable entry of the box and seal the control box using a compound.
- Standard type control boxes do not contain a terminal block. Wire the control units directly.

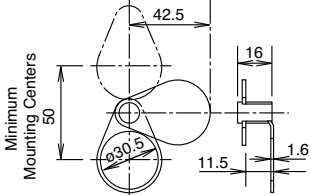
EC2A Flameproof and Increased Safety Control Boxes

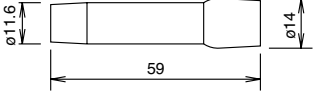
Accessories

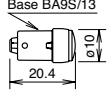
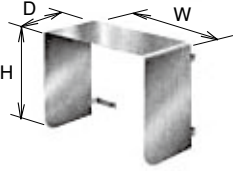
Name and Appearance	Part No. (Ordering Part No.)		Remarks and Dimensions (mm)				
	OL-C		<ul style="list-style-type: none"> Used to protect flush pushbuttons from inadvertent operation. Cannot be used with a nameplate. 				
	Color	Part No.	<ul style="list-style-type: none"> Replacement lens for pilot lights (with a gasket). For pure white illumination, use the EC9Z-LWPN10 white lens. The lens can be replaced from outside. Package quantity: 10 				
	Amber	EC9Z-LAPN10					
	Blue	EC9Z-LSPN10					
	Green	EC9Z-LGNPN10					
	Red	EC9Z-LRNPN10					
	White	EC9Z-LWPN10					
	Yellow	EC9Z-LYPN10					
	OR-55		Used to install and remove the LED lamps. 				
 	Operating Voltage	Current Draw		Part No.	Ordering Part No.	Illumination Color Code ②	Package Quantity
	6V AC/DC ±10%	DC		8 mA	LSTD-6②	A: Amber G: Green PW: Pure white R: Red S: Blue W: White	1 10
		7 mA (A, R, W) 5.5 mA (G, PW, S)	AC				
	12V AC/DC ±10%	10mA	11mA	LSTD-1②	LSTD-1②	1 10	
					LSTD-1②PN10		
	24V AC/DC ±10%	10mA	11mA	LSTD-2②	LSTD-2②	1 10	
							LSTD-2②PN10
	Applicable Control Box	Ordering Part No.	<ul style="list-style-type: none"> Protects control units from direct sunlight and rain. The surface of the control box shade is uncoated. Can be installed by tightening to the mounting tabs on the control box. The control box shade cannot be installed later. Specify a shade at time of order. 				
	EC2A-11*M, 21*M	EC9Z-F2A21M					
	EC2A-31*M	EC9Z-F2A31M					
	EC2A-410/510	EC9Z-F2A51					
	EC2A-220/320	EC9Z-F2A32					
	EC2A-420/520	EC9Z-F2A52					
	EC2A-230/330	EC9Z-F2A33					
	EC2A0-430/530	EC9Z-F2A53					
	Part No.	Dimension (mm)					
		H	W	D			
	EC9Z-F2A21M	180	160	160			
	EC9Z-F2A31M	230	160	160			
	EC9Z-F2A51	360	160	160			
	EC9Z-F2A32	260	420	160			
	EC9Z-F2A52	360	420	160			
	EC9Z-F2A33	260	510	160			
	EC9Z-F2A53	360	510	160			

EC2A Flameproof and Increased Safety Control Boxes

• Nameplate

Type	Legend	Specifications	Part No.	Ordering Part No.	Package Quantity	Dimensions (mm)
NA	Without Legend	Material: Aluminum Thickness: 1 mm White legend on black background	NA-0	NA-0	1	
				NA-0PN10	10	
	With Legend		NA-□	NA-□	1	
				NA-□PN10	10	

- Specify a legend code in place of □ in the Ordering Part No. of the nameplate.

[Nameplate Legend Code]

Code	Legend
1	ON
2	OFF
3	START
4	STOP
7	FORWARD
8	REVERSE
31	OFF-ON
35	HAND-AUTO
53	HAND-OFF-AUTO

EC2A Flameproof and Increased Safety Control Boxes

Part No. Development

The concept of the Part No. development is described below. For standard model Part No. of control boxes, see pages 5 to 21.

EC2A - 1 1 0 1 M F 2 N 1 0 (1 to 3 control units x 1 column)

EC2A - 5 1 5 3 N F 2 N 1 0 (others)

EC2A

Control Units x Columns	Code	Mounted Control Units and Positions from Top					Code
		1st	2nd	3rd	4th	5th	
1 x 1 (w/ or w/o wiring)	11	PL	-	-	-	-	01
		PB	-	-	-	-	02
		SS	-	-	-	-	06
		BZ	-	-	-	-	30
		M	-	-	-	-	50
2 x 1 (w/ or w/o wiring)	21	PL	PL	-	-	-	01
		PB	PB	-	-	-	02
		PB	SS	-	-	-	04
		PL	SS	-	-	-	07
		PL	PB	-	-	-	12
		BZ	PB	-	-	-	32
3 x 1 (w/ or w/o wiring)	31	PL	PL	PL	-	-	01
		PB	PB	PB	-	-	02
		PB	PB	SS	-	-	04
		SS	SS	SS	-	-	06
		PL	PB	PB	-	-	10
		PL	PB	SS	-	-	13
		PL	PL	SS	-	-	17
		M	PB	PB	-	-	52
		M	PL	SS	-	-	57
		M	PL	PB	-	-	50
4 x 1 (w/ or w/o wiring)	41	BZ	PL	PB	-	-	30
		BZ	PB	PB	-	-	32
		PL	PL	PL	PL	PL	01
		PB	PB	PB	PB	-	02
		PL	PL	PB	PB	-	10
5 x 1 (w/ or w/o wiring)	51	PL	PB	PB	SS	-	13
		M	PL	PB	PB	-	50
		M	PL	PB	PB	SS	53
		PL	PL	-	-	-	01
		PB	PB	-	-	-	02
		PB	PB	SS	-	-	04
4 x 2 (w/ or w/o wiring)	42	PL	PB	PB	-	-	10
		M	PB	PB	-	-	52
		M	PL	SS	-	-	57
5 x 2 (w/ or w/o wiring)	52	PL	PL	PB	PB	PB	10
		PL	PL	PB	PB	SS	13
		M	PL	PB	PB	-	50
2 x 3 (w/ or w/o wiring)	23	PL	PL	-	-	-	01
		PB	PB	-	-	-	02
3 x 3 (w/ or w/o wiring)	33	PL	PB	PB	-	-	10
		PB	PB	SS	-	-	04
		M	PB	PB	-	-	52
		M	PL	SS	-	-	57
4 x 3 (w/ or w/o wiring)	43	PL	PL	PB	PB	-	10
		PL	PB	PB	SS	-	13
5 x 3 (w/ or w/o wiring)	53	M	PL	PB	PB	-	50
		M	PL	PL	PB	PB	50
		PL	PL	PB	PB	SS	13

Lead-in Fitting		Code
Wall Mount (conduit lead-in)		Code
Conduit thread G3/4		F2
Conduit thread G1		F3
Wall Mount (flameproof packing)		Code
HPN21 R8		H1
HPN21 R10		H2
HPN21 R12		H3
HPN22 R14		H4
HPN22 R16		H5
HPN22 R18		H6
HPN33 R20		H7
Pole Mount (packing lead-in)		Code
One-column boxes are supplied with three different-size packings to connect cables of ø8 to ø20 in diameter. Two- and three-column boxes are supplied with three different-size packings to connect cables of ø14 to ø26 in diameter.		SF

Wiring	Code
Without	N
With	W

Standard or Non-standard	Code
Standard Model Serial Number	1 to 9

Control Unit Nameplate	Code
Not Needed	0

Designate 0 only when control nameplate is not needed.

Control Boxes with Same Type Test Approval No.

- Various control units can be custom assembled as TIIS and NEPSI approved products within the range of the same model type.

Box	Part No.	Mounted Control Units and Quantity							TIIS Type Test Approval No.	NEPSI Approval No.	
		PL	PB	SS	M	BZ	VR	OB			Total
1 x 1	EC2A-1101M	1							1	TC16767	GYJ16.1026X
	EC2A-1102M		1						1	TC16767	GYJ16.1026X
	EC2A-1106M			1					1	TC16768	GYJ16.1024X
	EC2A-1150M				1				1	TC16773	GYJ16.1030X
	EC2A-1130M					1			1	TC16771	GYJ16.1028X
2 x 1	EC2A-2112M	0-2	0-2						1-2	TC16767	GYJ16.1026X
	EC2A-2104M		0-2	0-2					1-2	TC16768	GYJ16.1024X
	EC2A-2107M	0-2		0-2					1-2	TC16769	GYJ16.1025X
	EC2A-2132M		0-2				1-2		1-2	TC16771	GYJ16.1028X
3 x 1	EC2A-2151M	0-2				1-2			1-2	TC16773	GYJ16.1030X
	EC2A-3113M, 3113MS	0-3	0-3	0-3					1-3	TC16776	GYJ16.1033X
	EC2A-3150M, 3150MS	0-3	0-3		1-2				1-3	TC16780	GYJ16.1037X
	EC2A-3154M, 3154MS	0-3	0-3	0-3	1-2				1-3	TC16782	GYJ16.1038X
	EC2A-3157M, 3157MS	0-3		0-3	1-2				1-3	TC16781	GYJ16.1039X
	EC2A-3130M, 3130MS	0-2	0-2			1-2			1-3	TC16777	GYJ16.1034X
5 x 1	EC2A-5150, 5150S	0-5	0-5	0-5	0-5	0-5			1-5	TC14279	GYJ16.1042X
3 x 2	EC2A-3253, 3253S	0-6	0-6	0-6	0-2	0-2	0-4	0-5	1-6	TC14280	GYJ16.1040X
5 x 2	EC2A-5253, 5253S	0-10	0-10	0-10	0-6	0-2	0-6	0-9	1-10	TC14281	GYJ16.1043X
3 x 3	EC2A-3353, 3353S	0-9	0-9	0-9	0-6	0-3	0-6	0-8	1-9	TC14282	GYJ16.1041X
5 x 3	EC2A-5353, 5353S	0-15	0-15	0-15	0-9	0-3	0-6	0-14	1-15	TC14283	GYJ16.1023X

EC2A Flameproof and Increased Safety Control Boxes

Operating Instructions

1. Installation Location

- (1) EC2A control boxes can be installed in zone 1 and zone 2 hazardous locations, and cannot be installed in zone 0 hazardous locations.
- (2) Do not place the EC2A control boxes in environments harsher than IP65.
- (3) Use the EC2A control box under ambient temperature of -20 to $+50^{\circ}\text{C}$. If the control box is exposed to direct sunlight and the surface temperature may rise above 50°C , provide a shade (see page 27) to keep the surface temperature below 50°C .

2. Installation

- (1) Wall mount type
Use four M6 bolts for the 1-column type or four M8 bolts for the 2- and 3-column types, or other methods with equivalent strength to install the control box. The thickness of the mounting tabs is 1.5 mm for the 1-column type and 2 mm for the 2- and 3-column types.
- (2) Pole mount type
Use four M12 bolts or other methods with equivalent strength to install the control box. Use flat washers to prevent scratches on the pole base coating.
- (3) If bolts may become loose due to vibration, use spring washers.
- (4) If bolt corrosion occurs, use anti-corrosion bolts or other countermeasures.

3. Opening/Closing the Lid

- (1) Use a Phillips screwdriver to loosen lid mounting screws (M5 x 12 stainless screws with spring and plain washers). Do not lose the removed screws. When opening the lid of boxes equipped with a hinge, hold the unhinged side, and open the lid slowly without exerting excessive force on the hinge.
- (2) Before closing the lid, make sure of the following:
 - No foreign substances on the gasket or joint surfaces.
 - No displacement of the waterproof gasket.
 - Wires are not caught between the joint surfaces.Next, close the lid slowly and tighten the lid mounting screws to a proper torque of 2.4 to 3.4 N·m.

4. Leading Conductors into the Control Box

• Wall Mount Type

- (1) Lead-in cables
 - When leading cables, use IDEC's HPN flameproof packing type cable lead-in fitting.
 - When choosing cables, take into consideration the chemical resistance and the maximum operating temperature of the EC2A control box. The cable should have as little space as possible to prevent ingress of explosive gas through the cable. Choose cables with smooth surfaces and round in cross-section. Size and insulation material of the cable must be selected in consideration of the temperature rise of the cable.
 - Make sure that the HPN flameproof packing type cable lead-in fitting fits with the cable outside diameter. If not, replace with a compatible cable or suitable lead-in fitting.
 - When installing the cables in zone 1 location or zone 2 location where the cables may subject to external damage, protect the cables from external damage by covering the cables within conduits, ducts, trays, or other protective provisions.
- (2) Lead-in metal conduits
 - Use cables of 600V polyvinyl chloride wires or superior insulated cables (except for outdoor polyvinyl chloride wires). Choose cable size and insulation material in consideration of the temperature rise of the insulated cables.
 - Use a heavy gauge steel conduit. Cut a parallel pipe

thread (G thread) on the heavy gauge steel conduit, and screw the conduit more than 5 turns into the control box and pipe fittings.

- On the conduit line, install a sealing fitting on either side of the boundary between hazardous areas, between hazardous and non-hazardous areas, and in the vicinity of the control box.

• Pole Mount Type

- (1) Parts Description

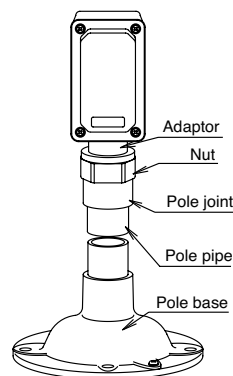

- (2) Notes for Wiring Cables

- Packing type cable lead-in method is used for the pole mount type and only one cable can be lead in.
- Make sure that the hole of the pole packing fits with the diameter of the lead-in cable. If the packing does not fit with the cable, replace with a cable or packing of the appropriate size.
- Protect the cable from external damage with protection such as metal conduits.
- The control box and the cable lead-in fitting can be separated so that the cable can be lead in easily. Follow the procedure as described below.

- (3) Leading in Cables

- Removing the control box
Turn the nut counterclockwise and remove the control box from the pole joint. The adaptor and nut should remain on the bottom of the control box.
- Leading in the cable
Loosen the gland on the pole joint and remove the slip ring and pole packing. Lead the cable through the pole base, the pole, and the pole joint.

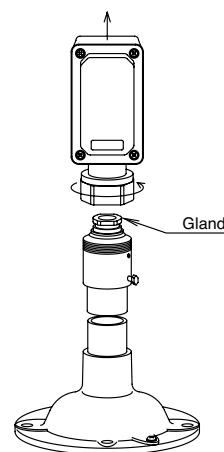

EC2A Flameproof and Increased Safety Control Boxes

- **Tightening the pole packing**
Install parts to the cable in the order of pole packing, slip ring, and gland. Screw the gland into the pole joint and tighten the pole packing. When the cable is tightened lightly with the gland, screw the gland 1/2 to 1 turn further.
- **Clamping the cable**
To clamp the cable at the center of the pole joint, evenly tighten two M5 set screws on the outside of the pole joint using a hexagon wrench and secure the cable with the clamp inside the pole joint.
- **Installing the control box**
Install the control box with the adaptor unit onto the pole joint, turn the nut of the adaptor unit clockwise until the control box and pole joint are tightened.

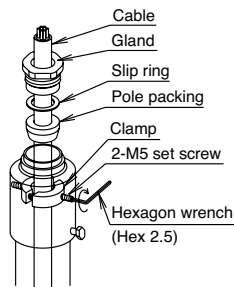
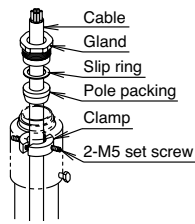

5. Wiring

- (1) Wire the cable correctly referring to the markings on the terminals and nameplate.
- (2) Use wires and cables of a proper size to meet the applied voltage and current.
- (3) For connecting cables or insulated wires to the terminal blocks, use ring type crimping terminals with an insulation. When connecting cables or insulated wires directly to the control units, use ring type crimping terminals without an insulation or ring type crimping terminals with an insulation sheath or marking tube. Make sure that the wires do not exert external force to the terminals.
- (4) Connectable wires are 3.5 mm² (AWG12) maximum. One or two wires can be connected to a terminal. The terminal screws are M4. Tighten the terminal screws to a recommended torque of 1.0 to 1.3 N·m. If the terminal become loose during operation, abnormal heating will be caused, resulting in fire hazard.
- (5) Applicable crimping terminal dimensions are shown below.

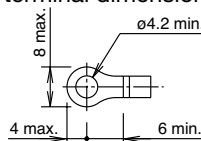

6. Protective Grounding

- (1) Connect the M4 grounding terminal of the EC2A control box to a proper ground (grounding resistance 10Ω maximum). When the EC2A control box is connected to circuits of 300V or below, the grounding resistance must be 100Ω maximum.
- (2) When using a cable for ground connection, connect one of the cable cores to the grounding terminal.
- (3) If the grounding terminal in the enclosure cannot be used, use the M4 grounding terminal on the outside of the enclosure.
- (4) For grounding, use a 600V polyvinyl chloride wire or superior insulated cable that can tolerate the expected maximum grounding current. Be sure to protect the grounding wire from external damage by using protection such as metal conduits.
Recommended tightening torque: 1.0 to 1.3 N·m

7. Control Units

• Installing Color Caps on Pushbuttons

- (1) When a pushbutton color code is not specified, three color caps in black, green, and red, are supplied. To install a color cap, align the projection on the back of the color cap with the pushbutton operator, and press the color cap to the bottom until it clicks.
- (2) Check that the color cap is attached firmly.

• Installing Nameplates

- (1) Before installing a nameplate, remove the anti-rotation projection on the nameplate using pliers.
- (2) When installing a nameplate on a pushbutton, pilot light, or selector switch, remove the locking ring. If a dummy nameplate is installed, remove the dummy nameplate. Then, install a nameplate and tighten the locking ring as before.
- (3) Applicable nameplate thickness: 1.2 mm maximum

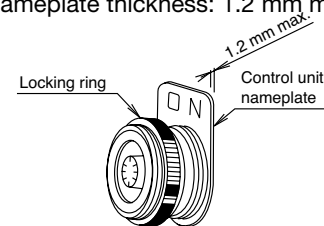

8. Pilot Lights

- (1) **Replacing Color Lens on Pilot Lights**
 - Turn the color lens counterclockwise.
 - Install the supplied gasket to the threaded part on the new lens, and install the color lens in the lamp cover as before. When using a tool, make sure that the lens is not damaged.

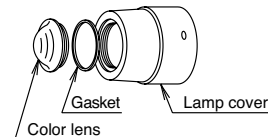

- (2) **Replacing LED Lamps in Pilot Lights**
 - Turn off the power to the pilot light.
 - Loosen the M4 set screw in the lamp cover using a hexagon wrench (Hex 2) by 2 turns. Turn the lamp cover counterclockwise to remove.

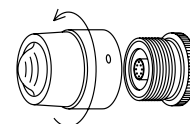
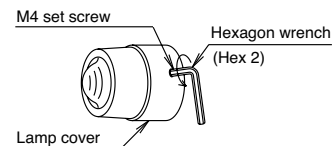

EC2A Flameproof and Increased Safety Control Boxes

- Using an optional lamp holder tool (OR-55), push the LED lamp and turn it counterclockwise to remove. Be careful of the LED lamp because it may be heated.

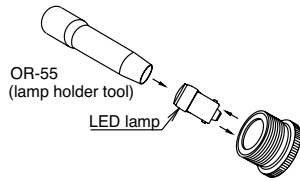

- Attach a new LED lamp of the same rating to the lamp holder tool, and insert the LED lamp into the socket. Push the LED lamp and turn it clockwise.
- Install the lamp cover by rotating 5 or more turns until it touches the waterproof gasket. Tighten the M4 set screw using a hexagon wrench.

9. Pointer Zero Adjustment and Red Pointer Adjustment

- Using a flat screwdriver (0.8mm thick x 5mm wide maximum), turn the zero adjustment pointer screw and the red pointer screw.
- Zero adjustment is possible only on AC ammeters. On other meters such as DC voltmeters and DC ammeters, zero adjustment is not possible.

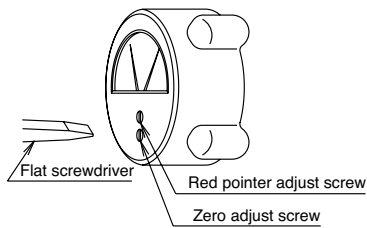

EC2A Flameproof and Increased Safety Control Boxes

Ordering Information

When Ordering Standard Models

When ordering standard models, specify the following items.

- (1) Part No. of the control box (see pages 5 to 21).
- (2) When ordering a control box with ammeters, specify the Part No. of the ammeter of the required capacity.

Part No.	Specifications
EC9F-M53A5N	Capacity: 5A Expansion scale: x3
EC9F-M53A10N	Capacity: 10/5A Expansion scale: x3
EC9F-M13A10N	Capacity: 10/1A Expansion scale: x3
EC9F-M53A15N	Capacity: 15/5A Expansion scale: x3
EC9F-M13A15N	Capacity: 15/1A Expansion scale: x3
EC9F-M13A20N	Capacity: 20/1A Expansion scale: x3
EC9F-M53A30N	Capacity: 30/5A Expansion scale: x3
EC9F-M13A30N	Capacity: 30/1A Expansion scale: x3
EC9F-M53A50N	Capacity: 50/5A Expansion scale: x3
EC9F-M53A60N	Capacity: 60/5A Expansion scale: x3
EC9F-M53A75N	Capacity: 75/5A Expansion scale: x3
EC9F-M53A100N	Capacity: 100/5A Expansion scale: x3
EC9F-M53A150N	Capacity: 150/5A Expansion scale: x3

[Ordering Example 1]

Wall mount, 1 column
standard control box

Part No.: EC2A-4154NF3N1

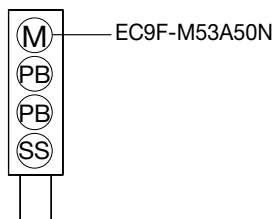

[Ordering Example 2]

Pole mount, 2 columns
standard control box

Part No.: EC2A-5120NF3N

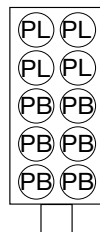

- (3) If nameplates are not required for pushbuttons or selector switches on standard control boxes, add "0" after the Part No.

[Example] EC2A-5120NF3N10

- (4) When ordering a control box with wiring and the wiring diagram is not found in the standard wiring diagrams (pages 22 and 23), specify your required wiring diagram.

EC2A Flameproof and Increased Safety Control Boxes

When Ordering Non-standard Models

1-column Control Boxes

When ordering 1-column control boxes with control units or nameplate legends not found in standard models, select your requirement from the table below.

Pilot Light	Pushbutton	Nameplate Legend	Selector Switch	Nameplate Legend	Buzzer
EC9E-L116DNR	EC9E-B111N	ON	EC9E-S311N	ON-OFF	EC9F-Z11N
EC9E-L126DNR	EC9E-B111N	OFF	EC9E-S311N	(blank)	EC9F-Z12N
EC9E-L122DNR	EC9E-B111N	START	EC9E-S3L11N	ON-OFF	
EC9E-L116DNG	EC9E-B111N	STOP	EC9E-S3L11N	(blank)	Meter
EC9E-L126DNG	EC9E-B111N	(blank)	EC9E-S3K11N	ON-OFF	EC9F-M53A5N
EC9E-L122DNG			EC9E-S3K11N	(blank)	EC9F-M53A10N
EC9E-L116DNW			EC9E-S411N	ON-OFF	EC9F-M13A10N
EC9E-L126DNW			EC9E-S411N	(blank)	EC9F-M53A15N
EC9E-L122DNW			EC9E-S4L11N	ON-OFF	EC9F-M13A15N
EC9E-L116DNA			EC9E-S4L11N	(blank)	EC9F-M13A20N
EC9E-L126DNA			EC9E-S4K11N	ON-OFF	EC9F-M53A30N
EC9E-L122DNA			EC9E-S4K11N	(blank)	EC9F-M13A30N
EC9E-L116DNY			EC9E-S311N	HAND-AUTO	EC9F-M53A50N
EC9E-L126DNY			EC9E-S3L11N	HAND-AUTO	EC9F-M53A60N
EC9E-L122DNY			EC9E-S3K11N	HAND-AUTO	EC9F-M53A75N
EC9E-L116DNS			EC9E-S411N	HAND-AUTO	EC9F-M53A100N
EC9E-L126DNS			EC9E-S4L11N	HAND-AUTO	EC9F-M53A150N
EC9E-L122DNS			EC9E-S4K11N	HAND-AUTO	
EC9E-L116DNPW			EC9E-S111N	HAND-OFF-AUTO	
EC9E-L126DNPW			EC9E-S1L11N	HAND-OFF-AUTO	
EC9E-L122DNPW			EC9E-S1K11N	HAND-OFF-AUTO	
			EC9E-S211N	HAND-OFF-AUTO	
			EC9E-S2L11N	HAND-OFF-AUTO	
			EC9E-S2K11N	HAND-OFF-AUTO	
			EC9E-S211N	(blank)	
			EC9E-S2L11N	(blank)	
			EC9E-S2K11N	(blank)	

- On the “EC2A 1-Column Type Control Box Specification Sheet,” put a check mark in the check box above your required control box. Enter mounting hole numbers ① to ⑤ to the right of your required control units in the table “Control Unit Part No.” to indicate the arrangement of the control units.
- The positions of control unit mounting holes cannot be changed.
- One lead-in fitting is supplied. Its mounting position cannot be changed.
- When other control units, nameplates, or lead-in fittings than listed above are required, specify your requirements separately. For available control unit specifications, see pages 24 to 26. Lead-in fittings, on page 26. Nameplate specifications, on page 28.

2- or 3-column Control Boxes

When ordering non-standard control units, nameplates, or lead-in fittings, specify your requirements separately.



Safety Precautions

- Do not open the lid of the EC2A control box during operation, otherwise electric shock, fire hazard, or explosion may result.
- Make sure that the operating conditions are within the specification values, otherwise electric shock, personal injury, or equipment damage may result.
- Turn off the power to the EC2A control box before installation, removal, wiring, maintenance, and inspection, otherwise electric shock or fire hazard may result.
- Read the catalog and instruction sheet for the EC2A control box to make sure of correct operation.

To: IDEC Corporation

Date: _____

(/)

EC2A 1-Column Control Box Specification Sheet

Company: _____

TEL: _____

No. of Control Boxes

Contact Person: _____

FAX: _____

EC2A-110

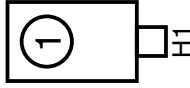

EC2A-210



EC2A-310

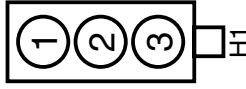

EC2A-410



EC2A-510



(H1: Metal conduits are installed with Standard control boxes)

Control Unit Part No.

Pilot Light	Control Unit Hole No.	Pushbutton	Control Unit Nameplate	Control Unit Hole No.	Selector Switch	Control Unit Nameplate	Control Unit Hole No.	Control Unit Nameplate	Control Unit Hole No.	Buzzer	Control Unit Hole No.
EC9E-L116DNR		EC9E-B111N	ON		EC9E-S311N	OFF-ON		EC9E-S3K11N		EC9F-Z11N	
EC9E-L126DNR		EC9E-B111N	OFF		EC9E-S311N	(blank)		EC9E-S411N		EC9F-Z12N	
EC9E-L122DNR		EC9E-B111N	START		EC9E-S3L11N	OFF-ON		EC9E-S4L11N			
EC9E-L116DNG		EC9E-B111N	STOP		EC9E-S3L11N	(blank)		EC9E-S4K11N			
EC9E-L126DNG		EC9E-B111N	(blank)		EC9E-S3K11N	OFF-ON		EC9E-S111N			
EC9E-L122DNG		EC9E-B111N	(blank)		EC9E-S3K11N	(blank)		EC9E-S1L11N			
EC9E-L116DNW		EC9E-L122DNG			EC9E-S411N	OFF-ON		EC9E-S1K11N		EC9F-M53A5N	
EC9E-L126DNW		EC9E-L122DNW			EC9E-S411N	(blank)		EC9E-S211N		EC9F-M53A10N	
EC9E-L122DNW		EC9E-L116DNA			EC9E-S4L11N	OFF-ON		EC9E-S2L11N		EC9F-M53A15N	
EC9E-L116DNA		EC9E-L126DNA			EC9E-S4L11N	(blank)		EC9E-S2K11N		EC9F-M13A15N	
EC9E-L126DNA		EC9E-L122DNA			EC9E-S4K11N	OFF-ON		EC9E-S211N	(blank)	EC9F-M13A20N	
EC9E-L116DNY		EC9E-L126DNY			EC9E-S4K11N	(blank)		EC9E-S2L11N	(blank)	EC9F-M53A30N	
EC9E-L126DNY		EC9E-L122DNY			EC9E-S311N	HAND-AUTO		EC9E-S2K11N	(blank)	EC9F-M13A30N	
EC9E-L116DNS		EC9E-L122DNS			EC9E-S3L11N	HAND-AUTO				EC9F-M53A50N	
EC9E-L126DNS										EC9F-M53A60N	
EC9E-L122DNS										EC9F-M53A75N	
										EC9F-M53A100N	
										EC9F-M53A150N	

How to Select the Control Unit

1. Choose the control box and mark the check box.
2. Choose the appropriate hole number and fill in the Control Unit Hole No.
3. Specify the wiring diagram when choosing control units with wiring.

IDEC CORPORATION

 www.idec.com

Head Office

6-64, Nishi-Miyahara-2-Chome, Yodogawa-ku, Osaka 532-0004, Japan

USA	IDEC Corporation	Tel: +1-408-747-0550	opencontact@idec.com	Taiwan	IDEC Taiwan Corporation	Tel: +886-2-2577-6938	service@tw.idec.com
Germany	APEM GmbH	Tel: +49-40-25 30 54-0	service@eu.idec.com	Hong Kong	IDEC Izumi (H.K.) Co., Ltd.	Tel: +852-2803-8989	info@hk.idec.com
Singapore	IDEC Izumi Asia Pte. Ltd.	Tel: +65-6746-1155	info@sg.idec.com	China/Shanghai	IDEC (Shanghai) Corporation	Tel: +86-21-6135-1515	idec@cn.idec.com
Thailand	IDEC Asia (Thailand) Co., Ltd	Tel: +66-2-392-9765	sales@th.idec.com	China/Shenzhen	IDEC (Shenzhen) Corporation	Tel: +86-755-8356-2977	idec@cn.idec.com
Australia	IDEC Australia Pty. Ltd.	Tel: +61-3-8523-5900	sales@au.idec.com	China/Beijing	IDEC (Beijing) Corporation	Tel: +86-10-6581-6131	idec@cn.idec.com
India	IDEC Controls India Private Limited	Tel: +91-80679-35328	info_india@idec.com	Japan	IDEC Corporation	Tel: +81-6-6398-2527	marketing@idec.co.jp

Specifications and other descriptions in this brochure are subject to change without notice.
Information in this brochure is current as of March, 2020.
2020 IDEC Corporation, All Rights Reserved.

EP1323-3

